

## **PLANNING APPLICATION NUMBER:P11/0262**

Type of approval sought	Full Planning Permission
Ward	KINGSWINFORD NORTH & WALLHEATH
Applicant	Mr M. HOWELL
Location:	<b>1, WATERFORD ROAD, KINGSWINFORD, KINGSWINFORD, DY6 7AH</b>
Proposal	<b>ERECTION OF 1 NO. DWELLING AND DETACHED GARAGE. NEW VEHICULAR ACCESS TO HIGHWAY.</b>
Recommendation Summary:	<b>APPROVE SUBJECT TO A 106 AGREEMENT</b>

### **SITE AND SURROUNDINGS**

1. The site occupies a prominent location on the corner of Waterford Road and Moss Grove. This is a predominantly residential area. Moss Grove forms part of the Strategic Highway Network. Currently there is a low boundary wall and beyond are the rather bland side gable and open garden of No. 1 Waterford Road which are readily visible.

### **PROPOSAL**

2. The application is for the erection of 1 No. three bedroom, detached house and a detached garage. The house would be constructed adjacent to the side gable of No. 1 Waterford Road. The existing ground floor, side facing, kitchen window of No 1. Waterford Road, which is a secondary light source to the room, would be removed. Rear pedestrian access to the rear of the existing dwelling and the new dwelling would be maintained by a shared walkway within the current application site.
3. Since submission the application has been amended to slightly reduce the height and depth of the building and move it slightly forward into line with the building line in Waterford Road. Other amendments comprise the provision of one rather than two parking spaces at the front of the dwelling, the retention of more of the existing

boundary wall and confirmation of the shared pedestrian access for the new and existing dwelling.

4. The new dwelling would have a front elevation to Waterford Road. The maximum length of the dwelling would be 10.7m and the maximum width would be 7.6m. The ridge height would closely match that of the adjacent dwelling. The design would contain one gable to the front of the building and two staggered gables fronting Moss Grove. The building line along Waterford Road would be retained and the new dwelling would project approximately 1.2m beyond the rear of the existing adjacent dwelling.
5. One off-street parking space would be provided off Waterford Road. Landscaping would take place behind the existing low wall at the front and side of the new dwelling. A 1.8m high wall would be set back behind landscaping to provide privacy to the new rear garden.
6. Part of the existing wall which faces Moss Grove would be removed to enable a new driveway to be provided. This would provide access to a new garage and a turning area to prevent vehicles reversing out onto the adjacent highway. The pitched roofed, detached garage would be constructed adjacent to the blank gable wall of No. 42 Moss Grove. Internally it would measure 6.0m by 3.2m.
7. The garden of the new dwelling would be “L” shaped requiring land to be taken from the rear gardens of Nos 1 and 3 Waterford Road. The gardens of these two dwellings would be reduced in length to approximately 10.9m.

## HISTORY

### 8. Relevant History

<b>APPLICATION No.</b>	<b>PROPOSAL</b>	<b>DECISION</b>	<b>DATE</b>
DB/69/5484	Erection of 5No. detached houses with integral garages	Approved	11/07/69
80/52151	Erection of porch, external and internal alterations	Approved	07/08/80

## PUBLIC CONSULTATION

9. Letters have been sent to adjacent and dwellings which are in close proximity to the site. Two letters of objection have been received to the initial plan and the same two objectors have reiterated the same objections to the amended scheme. These residents make the following comments:

- Modern dwellings being constructed on ever smaller plots;
- The fact that it requires two points of vehicular access indicates that the plot is too small;
- Two adjacent gardens converted from reasonable to small will affect their value;
- The highway access onto Waterford Road will add to the significant congestion which exists in the road due to the nearby GP surgery and postal sorting office;
- At school times and peak hours the traffic is significant. The new access close to the junction with Moss Grove will add to congestion and could cause an accident;
- The dwelling may interfere with the line of sight for traffic moving onto Moss Grove from Waterford Road;
- The building projects well in front of the building line relative to existing properties in Moss Grove and is extremely close to the boundary of the plot;
- The elevation to Moss Grove would be very imposing and not in keeping with the current street scene, resulting in overdevelopment;
- The access to Moss Grove would add further disruption and congestion to Moss Grove.

## OTHER CONSULTATION

10. Group Engineer - Development – The level of car parking provision and the turning facility for vehicles entering/exiting the site from Moss Grove are acceptable. Subject to a contribution to highway infrastructure, I have no objection to the scheme.
11. Head of Environmental Health and Trading Standards - no adverse comments.

## RELEVANT PLANNING POLICY

12. National Planning Guidance
  - PPS3 – Housing
  - PPG13 – Transport
13. Regional Planning Guidance

The High Court Decision on 10<sup>th</sup> November 2010 in respect of the challenge by Cala Homes (South) Ltd (2010 EWHC 2866) quashed the Government's decision on 6<sup>th</sup> July 2010 to revoke the Regional Strategies. As a consequence the West Midlands Regional Spatial Strategy forms an ongoing part of the development plan.

The Chief Planner at the Department for Communities and Local Government wrote to all local authorities setting out that the Secretary of State expected them, and the Planning Inspectorate, to have regard to his letter of 27<sup>th</sup> May 2010, announcing his intention to abolish the Regional Strategies, as a material consideration in planning decisions.

However as the Regional Strategy still forms part of the development plan until it is abolished the following policies are considered relevant to the material consideration of this planning application:

- Policy QE3 – Creating a high quality built environment for all

14. Black Country Joint Core Strategy  
DEL 1 Infrastructure Provision  
DEL2 Managing the Balance Between Employment Land and Housing  
HOU2 Housing density, Type and Accessibility
14. Unitary Development Plan Policies  
DD1 Urban Design  
DD4 Development in Residential Areas
15. Supplementary Planning Documents / Guidance  
Parking Standards and Travel Plans Supplementary Planning Document  
New Housing Development Supplementary Planning Document  
Planning Obligations Supplementary Planning Document  
PGN3. New housing development

## ASSESSMENT

16. Key Issues
- Principle
  - Density
  - Design and appearance
  - Access and parking
  - Planning Obligations
- Principle
17. Recent amendments to Planning Policy Statement “Housing” (June 2010) has removed private residential gardens from the definition of “previously developed land.” As such there is no longer a presumption in favour of development on such garden land. However, whilst this document amends the approach to be taken in respect of such land it does not prohibit its development. Such applications can be considered on their merits based on policies contained in the development plan and all other material considerations.

18. This corner site has a rather open appearance when viewed above the existing low frontage wall. The bland side gable wall of the existing dwelling, No 1 Waterford Road is of low visual quality and, when taken into account with the lack of vegetation, it is considered that it does not have a positive impact on the immediate character of the area.
19. The building line along the eastern side of Moss Grove fluctuates within the vicinity of the site. Nos 50 to 60b are a row of traditional terraced properties with small front gardens which face onto Moss Grove. Directly south of these is a block of new houses and flats which again are built close to the back of the pavement. No. 42 Moss Grove is situated between these new flats and the application site. This is an old detached dwelling whose front garden decreases in width from 7.2m to 5.2m. On the opposite side of Waterford Road No. 38 Moss Grove and houses directly to the south are large detached dwellings that are set back at least 11.0m from the back of the pavement. Given this lack of uniformity of building line within the vicinity of the site it is considered that the development of this site would not be unduly out of character.

#### Density

20. The density of the development in the immediate vicinity of the site is generally low. Both Nos. 38 and 42 Moss Grove have densities of 16.6 dwellings per hectare (dph). Nos. 3 and 5 Waterford Close have densities of 33.3 dph. The application site would have a density of 20 dph. Given the varied nature of densities around the site it is considered that the new development would not be out of character, in terms of density, with nearby properties.

#### Design and appearance

21. The development would comprise a two storey, three bedroom detached dwelling. The site occupies a prominent corner location, in consequence, the house has been designed so that it presents frontages to both Waterford Road and Moss Grove. It would be slightly wider than No. 1 Waterford Road and the plans have been amended

so that the height of the new dwelling would be similar to the existing adjacent dwelling.

It is considered that the building has been well designed and indeed that its construction would remove the current open view of the rather unattractive side elevation of No1. Waterford Road.

22. Landscaping is indicated to the front and side of the new dwelling behind the existing low boundary wall. A 1.8m high wall would be constructed parallel with Moss Grove leading from the rear of the house to the turning area which would provide privacy to the rear garden area. A landscaped area between this wall and the existing boundary wall would soften the impact of the development when viewed from Moss Grove.

#### Access and parking

23. One parking space is indicated in front of the building off Waterford Road. There would also be a new access created off Moss Grove. This would lead to a detached garage with a pitched roof (6.0m by 3.3m internally). A turning area would also be provided to enable vehicles to turn within the site allowing vehicles to enter and leave in a forward gear. The Group Engineer is supportive of the scheme.

#### Planning Obligations

24. Black Country Core Strategy Policy DEL1 'Infrastructure Provision' sets out the adopted policy framework for Planning Obligations within Dudley and the Planning Obligations SPD provides further detail on the implementation of this policy. These policy documents were prepared in accordance with national legislation and guidance on planning obligations.
25. Policy DEL1 requires all new developments to be supported by sufficient on and off-site infrastructure to serve the development, mitigate its impact on the environment, and ensure that the development is sustainable and contributes to the proper planning of the wider area.

26. In addition to applying Policy DEL1 and the SPD, in identifying the required planning obligations on this application the following three tests as set out in the CIL Regulations (April 2010), in particular Regulation 122, have been applied to ensure that the application is treated on its own merits:

- (g) necessary to make the development acceptable in planning terms;
- (h) directly related to the development;
- (i) fairly and reasonably related in scale and kind to the development.

27. In consideration of the above the required Planning Obligations on this application have been identified as follows and would need to be secured within a S106 Agreement:

• POS Construction	£537.91
• POS Establishment	£776.83
• Play Construction	£1,246.40
• Play Establishment	£0
• Libraries	£191.39
• Public Realm	£478.53
• Nature Conservation	£68.80
• Transport Improvements	£415.35
• Monitoring Charge	£250
• <b><u>Total Monies</u></b>	<b><u>£3,965.21</u></b>

28. The applicant has agreed to the payment of these offsite planning obligations at the date of agenda preparation.

## CONCLUSION

29. It is considered that the construction of a well designed dwelling on this prominent corner site would replace the vistas of the current, rather bland development. Given the varying nature of building lines along Moss Grove and the variation of densities of development within close proximity it is considered that it would be in keeping with the character of the area. Access to the site and the number of off-street parking



spaces provided are also considered to be acceptable. On this basis the application is compliant with Planning Policy Statement 3 “Housing” Planning Policy Statement 13 “Transport”, Policy DEL1 of the Joint Core Strategy, Policies DD1 and DD4 of the adopted Dudley Unitary Development Plan, Parking Standards and Travel Plans Supplementary Planning Document, New Housing Development Supplementary Planning Document and Planning Obligations Supplementary Planning Document.

## RECOMMENDATION

30. It is recommended that the application be approved subject to:
- a) The applicant entering into a Section 106 Legal Agreement for a contribution to off site public open space provision, enhancement and maintenance, libraries, public realm, nature conservation and transport improvements. The total cost of the contribution would be £3965.21.
  - b) The Scheme shall include the method, timing and arrangements including a means to guarantee a financial payment, increased through index linking from the first April each subsequent year, in accordance with the Council’s planning obligations policies.
  - c) The following conditions, with delegated powers to the Director of the Urban Environment to make amendments to these as necessary

### Reason for approval

It is considered that the construction of a well designed dwelling on this prominent corner site would replace the vistas of the current, rather bland development. Given the varying nature of building lines along Moss Grove and the variation of densities of development within close proximity it is considered that it would be in keeping with the character of the area. Access to the site and the number of off-street parking spaces provided are also considered to be acceptable. On this basis the application is compliant with Planning Policy Statement 3 “Housing” Planning Policy Statement 13 “Transport”, Policy DEL1 of the Joint Core Strategy, Policies DD1 and DD4 of the

adopted Dudley Unitary Development Plan, Parking Standards and Travel Plans Supplementary Planning Document, New Housing Development Supplementary Planning Document and Planning Obligations Supplementary Planning Document.

Conditions and/or reasons:

1. The development hereby permitted shall be begun before the expiration of three years from the date of this permission.
2. Prior to the occupation of the dwelling hereby approved, the parking and turning area shown on the approved plan[1084:01A shall be provided and thereafter maintained for these purposes for the lifetime of the development.
3. Prior to the commencement of development, details of the existing and proposed levels of the site (including finished floor levels), which should be related to those of adjoining land and highways, shall be submitted to and approved in writing by the local planning authority. The development shall proceed in accordance with the approved levels.
4. Prior to the commencement of development, details of the types, colours and textures of the materials to be used on the external surfaces of the buildings hereby approved shall be submitted to and approved in writing by the Local Planning Authority. The development shall be carried out in complete accordance with the approved details.
5. Prior to the commencement of development, details of the landscaping scheme for the site shall be submitted to and approved in writing by the Local Planning Authority. The agreed scheme shall be implemented in accordance with the approved details before the end of the first planting season following initial occupation of the development.
6. Prior to the commencement of development, details of the boundary treatments to be installed on the whole site shall be submitted to and approved in writing by the Local Planning Authority. These details shall include location of boundary treatment. Elevation details shall also be supplied, or planting species/distances, as appropriate. The development shall proceed in accordance with the approved details, which shall be installed on site prior to occupation and thereafter maintained for the lifetime of the development unless otherwise agreed in writing by the Local Planning Authority.
7. The landscaped areas shall be retained in the form shown on the approved plan throughout the life of the development and shall not be used for any other purpose, unless otherwise agreed in writing by the local planning authority.
8. Notwithstanding the provisions of the Town and Country Planning (General Permitted Development) Order 1995 (or any order revoking or re-enacting that order with or without modification) no development referred to in Schedule 2 Part 1 Class A, B, C of that order shall be carried out.
9. The development hereby permitted shall be carried out in accordance with the following approved plans: 1084:01A

10. The hardstanding accessed from Waterford Road, shown on the approved plan shall not be enlarged at any time throughout the life of the development.
11. Prior to the occupation of the dwelling, the garage shown on the approved plan shall be provided, shall be used only for the parking of vehicles connected with the occupation of the dwelling and shall be retained for the life of the development.
12. Development shall not begin until a scheme for protecting the proposed dwelling from noise from the adjacent roads has been submitted to and approved in writing by the local planning authority and all works which form part of the scheme shall be completed before the permitted dwelling is occupied, unless otherwise agreed in writing by the Local Planning Authority.

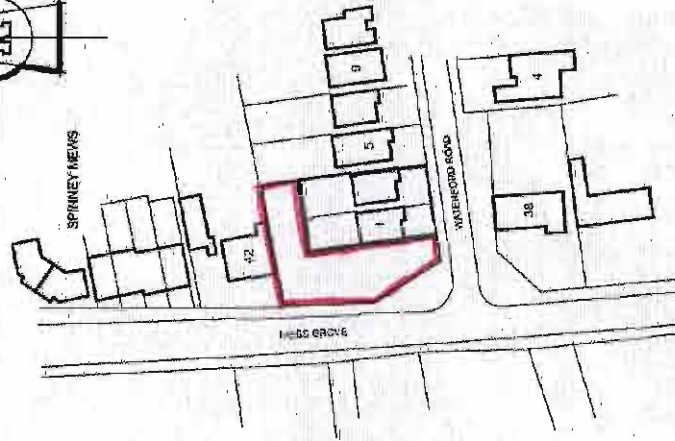
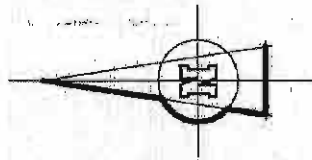

LOCATION PLAN  
1:1000



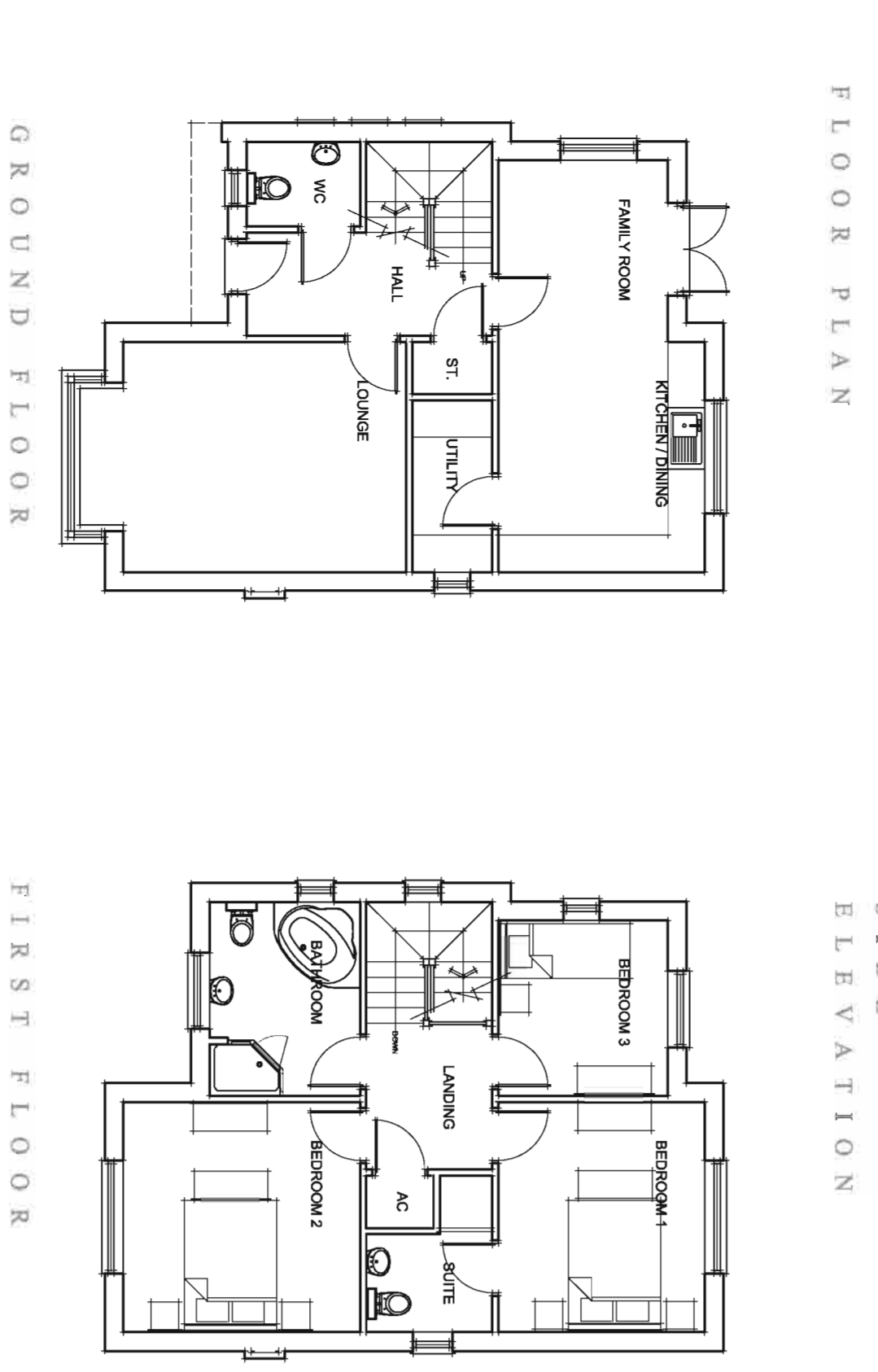
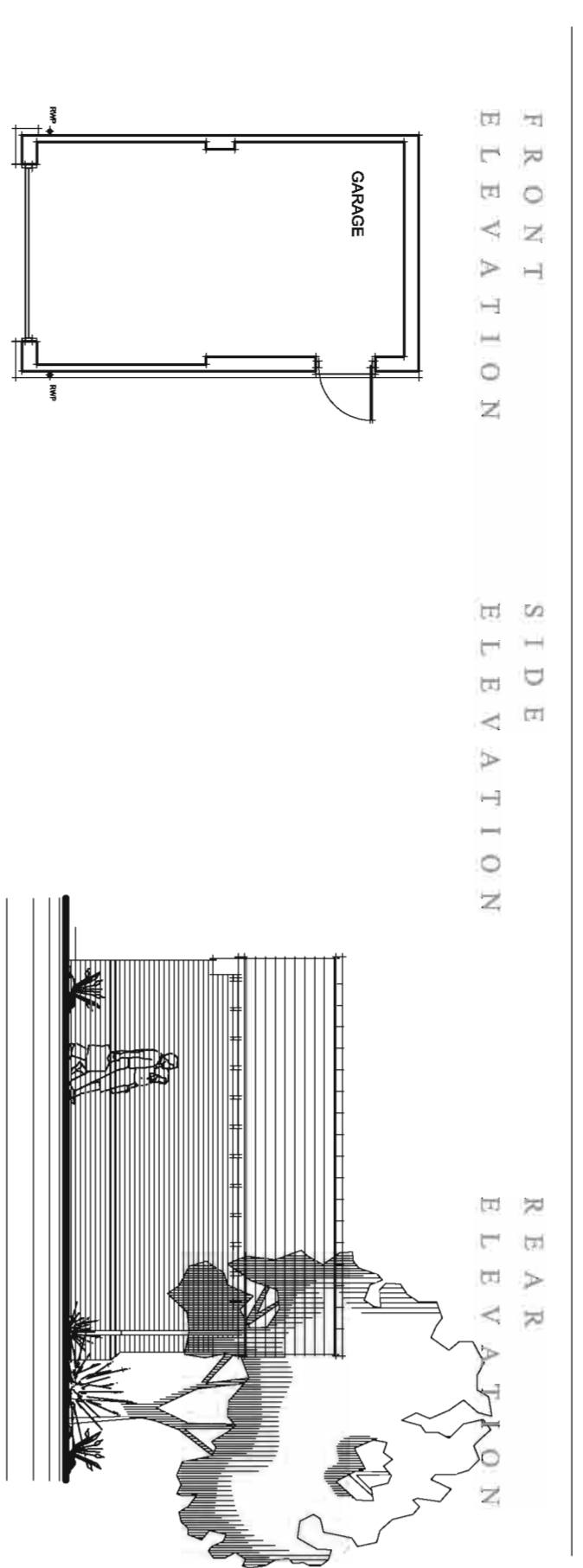
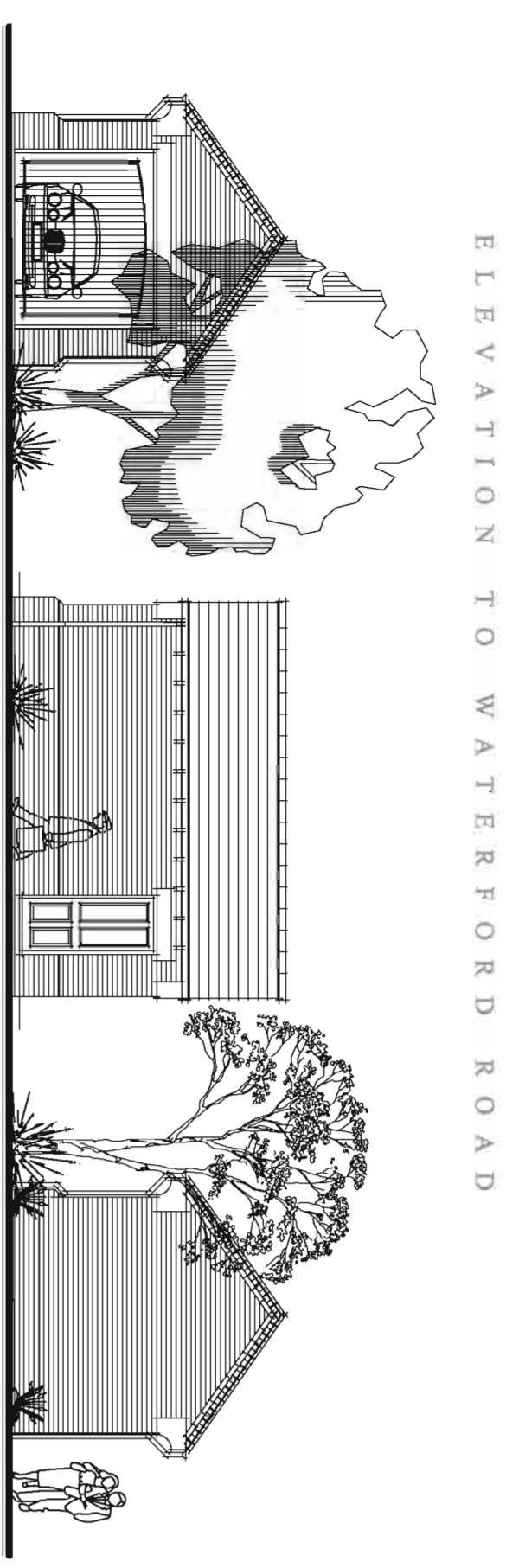
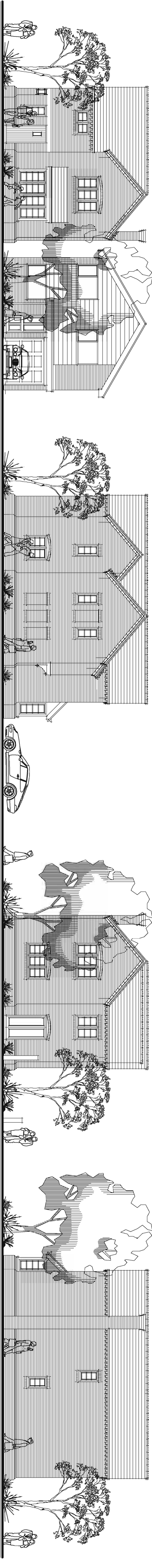

FORM 2.0M WIDE DRIVEWAY OPENING BY REMOVING A SMALL SECTION OF THE EXISTING 1.0M HIGH BOUNDARY WALL.

PROPOSED DRIVE AND TURNING AREA TO ALLOW VEHICLES TO ENTER AND EXIT THE SITE IN A FORWARD GEAR.

PROPOSED DWELLING OF SIMILAR FOOTPRINT TO ADJACENT HOUSES, DESIGNED WITH TYPICAL LINEAR DRIVEWAY OPENING TO ALLOW VEHICLES TO ENTER AND EXIT THE DRIVEWAY IN A FORWARD GEAR.

OPPORTUNITY TO REMOVE BLIND SIDE ELEVATION TO MOSS GROVE.

PROVIDE TWO PARKING SPACES ACCESSED OFF WATERFORD ROAD.

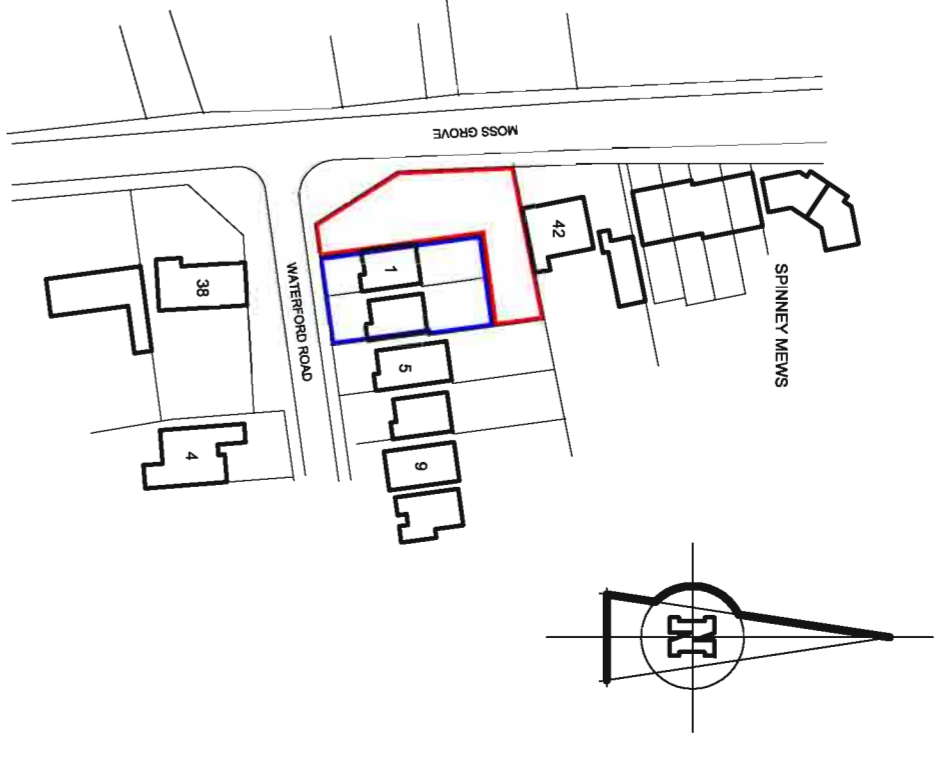
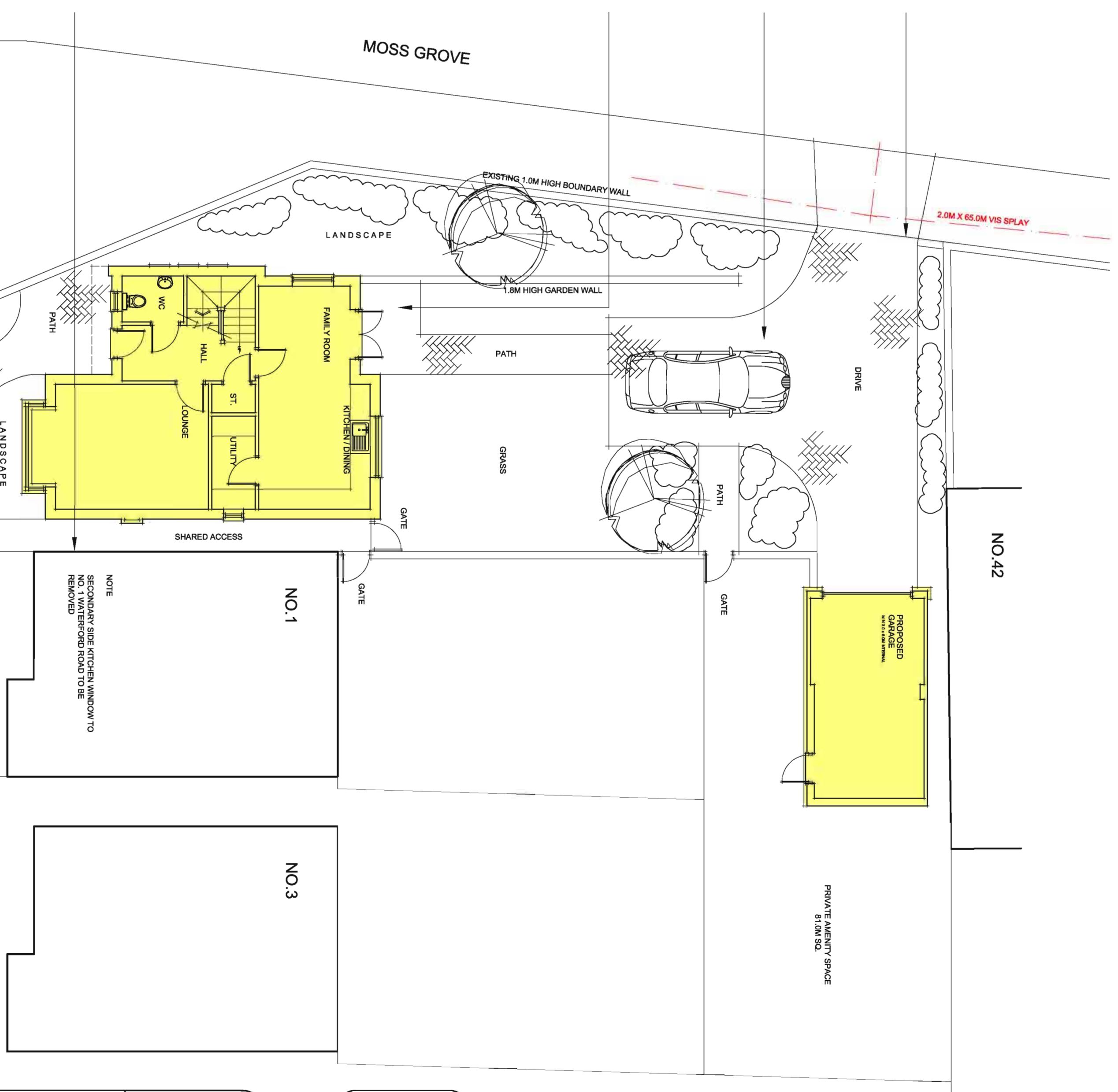

LOCATION PLAN  
1 : 1250

REVISIONS FOLLOWING AMENDMENTS CARRIED OUT TO SATISFY PLANNERS REQUIREMENTS:  
OVERALL LENGTH OF BUILDING REDUCED BY 500MM.  
BUILDING REPOSITIONED 600MM CLOSER TOWARDS WATERFORD ROAD.  
REMOVAL OF TWO PARKING SPACES TO WATERFORD ROAD.  
SHARED ACCESS PATH INDICATED BETWEEN NO.1 AND THE NEW DWELLING.  
30.03.2011

The Contractor is to check and verify all building and site dimensions, levels and sewer invert levels at connection points before work starts. This drawing must be read with and checked against any structural or other specialist drawings provided.  
The Contractor is to comply in all respects with the current building regulations whether or not specifically stated on these drawings.



158 Ivyhouse Lane, Coaley  
Dudley, West Midlands  
Telephone : (01902) 887337  
Fax : (01902) 887255  
Email : designtobuild@btconnect.com

Job: **proposed dwelling at land adjacent to 1 WATERFORD ROAD KINGSWINFORD**

Title: **scheme drawing**

Client: **MR. MARTIN HOWELL  
MR. MALCOLM HOWELL**

Scale: 1:100 1:200 Date: JAN 2011

Drawing No. **1084:01A**

Drawn By: CJH

Architects Building Management and Development Consultants

VIEW

SITE PLAN

