

PLANNING APPLICATION NUMBER:P11/1511

Type of approval sought	Full Planning Permission
Ward	Wordsley
Applicant	Shropshire Homes Ltd
Location:	BUILDING 12, FORMER WORDSLEY HOSPITAL, STREAM ROAD, WORDSLEY, WEST MIDLANDS
Proposal	CONVERSION OF EXISTING BUILDING TO 11 APARTMENTS WITH ASSOCIATED PARKING (RESUBMISSION OF WITHDRAWN PLANNING APPLICATION P11/0727)
Recommendation Summary:	APPROVE SUBJECT TO CONDITIONS

SITE AND SURROUNDINGS

- 1 The application relates to building 12, which was formally used as the hospital's boiler house. The building like the other retained building dates from the late 19th century.
- 2 The building that is the subject of this application, unlike the retained ward and administration buildings, has a more industrial appearance, with windows more typical of such buildings. The building also retains the existing chimney which is a distracting landmark within and adjoining the site.
- 3 The building adjoins one of the ward buildings to the west, public open space to the north and new build housing to the south and east.

PROPOSAL

- 4 Planning permission has previously been granted for the conversion of this building into 4 one-bedroom and 3 two-bedroom apartments (P06/1640). This application seeks to convert the building into 11, one-bedroom flats over three floors.

- 5 The layout includes parking within the confines of the site with room for 17 cars. The ground floor flats to the eastern side of the block will have their own private gardens.
- 6 The application is submitted with a design and access statement.
- 7 This application is a resubmission of a similar application which was withdrawn during the summer.

HISTORY

Building 12 (Boiler House)

APPLICATION	PROPOSAL	DECISION	DATE
P06/1640	Residential development of 331 dwelling units to include part demolition and part conversion of existing buildings, and provision of associated open space, play provision, roads, parking and a pedestrian crossing on Auckland Road.	Granted	14-Nov-2006
P11/0727	Conversion of existing building to 11 apartments with associated parking	Withdrawn	11-Aug-2011

- 8 Planning application P06/1640 originally granted planning permission to convert the building into seven flats over two floors. A further application (P11/0727) was submitted in June 2011. This was withdrawn as the application could not be supported from a design, neighbour amenity and highway safety point of view.

Other Applications

APPLICATION No.	PROPOSAL	DECISION	DATE
P06/0084	Conservation Area Consent to demolish unsafe structures (retrospective)	Granted	08-Mar-2006
P06/1641	Conservation area consent for demolition and part demolition of buildings and structures.	Granted	28-Nov-2006
P07/0814	Substitution of house types on previous approval P06/1640 (plots 3-10)	Granted	05-Jun-2007
P07/1182	Substitution of house types to plots 1-82	Granted	11-Sep-2007
P07/1234	Substitution of 78 house and apartment types on plots 1-2, 11-65 and 80-97 of previous approval P06/1640.	Granted	17-Sep-2007
P07/1695	Display various signage and 2 No. flagpoles (retrospective)	Granted	24-Oct-2007
P07/1696	Erection of temporary sales cabin and associated footpath, steps and landscaping (retrospective)	Granted	24-Oct-2007
P07/1967	Substitution of 97 No. house types plots 83-110, 174-179 and 111-173 of previous approval P06/1640	Granted	18-Dec-2007
P08/0390	Substitution of 29 house and apartment types on plots 83-92, 97-101 and 129-142 of previous	Granted	04-Jun-2008

	approval P06/1640. Erection of 3 No. additional dwellings.		
P08/1687	Substitution of house types on plots 41-54 & 61-65 of previously approved application P06/1640	Granted	21-Jan-2009
P08/1917	Substitution of Plots 102 & 103 with one dwelling (Plot 103)	Granted	11-Feb-2009
P09/0721	Erection of retaining walls and associated works (part retrospective).	Granted	31-Jul-2009
P09/0952	Substitution of house types on plots 1-9, 110-179, 183-187 of previously approved application P06/1640	Granted	15-Oct-2009
P09/1032	Creation of 34 Residential Units. - Conversion of buildings 3, 4 13 and 14 to residential use (including extension to building 4), conversion of part of building 2 to residential. Extension to building 2 to provide residential accommodation. Provision of associated parking, bin and cycle stores. (Amendment to P06/1640).	Granted	15-Oct-2010
P09/1648	Amendment to planning approval P06/1640 to increase dwellings to blocks 8, 9 and 17 from 24 to 31, bin store and associated car parking.	Granted	24-Feb-2010
P10/0206	Conversion of basement of	Granted	16-Jul-

	Block 2 The Clock House into 3 no. apartments with additional car parking,		2010
P10/1359	Amendment to approved application P10/0206 to create 4 no. apartments in the basement of block 2 (The Clock Tower) by subdividing 1 no. large apartment into 2 no. apartments.	Refused and Dismissed at subsequent appeal.	25-Nov-2010
P10/1697	Amendment to approved application P10/0206 to create 4 no. apartments in the basement of block 2 (The Clock Tower) by subdividing 1 no. large apartment into 2 no. apartments (resubmission of refused application P10/1359)	Granted	03-Feb-2011
P11/0727	Conversion of existing building to 11 apartments with associated parking	Withdrawn	11-Aug-2011
P11/0730	Conversion of existing building to 6 No. apartments with associated parking. (Building 1)	Resolution to approve	

PUBLIC CONSULTATION

9 Notification letters were sent to over 50 neighbouring properties and the application was advertised with a site notice and within the local press. Three Letters of objection received. Main issues raised:-

- Insufficient parking at present
- Parking could block foot access

- No turning head
- There is already limited manoeuvring space on the private drive
- Will not give consent for use of private drive by new occupiers
- Will lead to neighbour disputes
- Drive is privately owned, and maintained by occupiers of nos. 16 to 22
- Extra traffic will lead extra wear and tear
- Lack of parking for visitors
- Devaluation of property values

OTHER CONSULTATION

- 10 Group Engineer (Development) - Considers the parking to be remote which could result in cars being parked in Clock Tower View or the cul-de-sac serving the proposed development and adjoining houses.
- 11 Head of Environmental Health and Trading Standards - No objection subject to conditions in respect of contamination.
- 12 West Midlands Fire Service – No objection
- 13 West Midlands Police - No objection in principle. The bin and bike stores should not be metal. Lead should be used before first floor level. Trees and lighting in close proximity to the car park area should be seriously considered, as trees obscure natural surveillance and light columns.

RELEVANT PLANNING POLICY

- National Planning Guidance

PPS1 - Delivering Sustainable Development

PPS3 – Housing

PPS5 – Planning for the Historic Environment

The Draft National Planning Policy Framework (NPPF) was published for consultation on 25 July 2011. It is a consultation document and therefore subject to potential amendment;

however, the Planning Inspectorate have issued guidance which makes it clear that the NPPF is capable of being a material consideration and therefore regard has to be had for the document. However, given the early stage of development that the document is in, the weight to be given to it will be a matter for the decision maker in each particular case. The current Planning Policy Statements, Guidance notes and Circulars remain in place until cancelled.

- Regional Planning Guidance

The High Court Decision on 10 November 2010 in respect of the challenge by Cala Homes (South) Ltd (2010 EWHC 2866) quashed the Government's decision on 6 July 2010 to revoke the Regional Strategies. As a consequence the West Midlands Regional Spatial Strategy forms an ongoing part of the development plan.

The Chief Planner at the Department for Communities and Local Government wrote to all local authorities setting out that the Secretary of State expected them, and the Planning Inspectorate, to have regard to his letter of 27 May 2010, announcing his intention to abolish the Regional Strategies through the introduction of the emerging Localism Bill, as a material consideration in planning decisions.

The Localism Bill received Royal Assent on the 16 November 2011 becoming law; and confirmed the Government's intention to revoke Regional Strategies. In the coming months the measures in the Localism Act will begin to come into effect but the abolition of the RSS will not happen until the end of January at the earliest as the Government is currently consulting on the environmental impact of the abolition. Therefore the RSS policies still form part of the development plan until such point, and the following policies are considered relevant to the material consideration of this planning application.

- Black Country Joint Core Strategy

CSP2 Development Outside the Growth Network

CSP4 Place Making

DEL1 Infrastructure Provision

HOU1 Delivering Sustainable Housing Growth

HOU2 Housing Density, Type and Accessibility
ENV 1 Nature Conservation
ENV 2 Historic Character and Local Distinctiveness
ENV 3 Design Quality

- Unitary Development Plan

DD1 Urban Design
DD4 Development in Residential Areas
DD10 Nature Conservation and Development
UR9 Contaminated Land
LR1 Open Space
LR3 Children's Play Areas
NC1 Biodiversity
NC6 Wildlife Species
NC9 Mature Trees
NC10 The Urban Forest
HE4 Conservation Areas
HE5 Buildings of Local Historic Importance
EP7 Noise Pollution

- Supplementary Planning Guidance/Documents

Open Space, Sport and Recreation Provision Supplementary Planning Document
Nature Conservation Supplementary Planning Document
Historic Environment Supplementary Planning Document
Parking Standards and Travel Plans Supplementary Planning Document
New Housing Development Supplementary Planning Document
Planning Obligations Supplementary Planning Document
Design for Community Safety Supplementary Planning Guidance
PGN3. New housing development

ASSESSMENT

- 14 The main issues are
- Principle
 - Design
 - Neighbour Amenity
 - Occupier Amenity
 - Access and Parking
 - Planning Obligations

Principle

- 15 The principle of converting the building is considered to be acceptable, in that the former hospital site is identified as a major housing site within policy H1 of the adopted Unitary Development Plan. Moreover, planning permission has already been granted for a similar proposal which is still extant. However, consideration still needs to be given to all other material planning matters.

Design

- 16 The application building as described above differs from the other buildings on the site, as it was used as the hospital boiler house and as such has a more industrial appearance. In fact the tall brick chimney to the boiler house is still in place.
- 17 The proposed scheme retains a significant amount of the of the buildings character with new openings being kept to a minimum, with the majority of the door and windows to the flats reutilising or adapting existing openings. In addition the later extensions/alterations are to be removed which would improve the appearance of the building.
- 18 It is essential that appropriate conditions are in place to ensure the detailing to the doors and windows is appropriate to the character of the building. The Historic

Environment Team has been consulted on the application and have given their support to the proposal.

Neighbour Amenity

- 19 At the date of the earlier application (P11/0727) the only dwellings which were occupied immediately adjoining the site faced onto Kirkpatrick Drive. The separation distance between the rear of these dwellings and the first floor windows is 22m which is in accordance with the Councils adopted standards.
- 20 The separation distance between the windows in the boiler house and the recently completed houses on the private drive off Clock Tower View remains unchanged at 13m from the P06/1640 permission. Whilst this is less than required by the adopted standards, this is a front to front arrangement rather than the more sensitive back to back arrangement which exists with the properties to Kirkpatrick Drive. In addition one of these windows at first floor level is high level, another serves a landing area, and the other is a secondary window to a kitchen/living/diner. Both of these can be obscure glazed to reduce the likelihood of overlooking.
- 21 The relationship between Block 9 (former ward building) and the former boiler house remains unchanged from what has been previously approved. This building is yet to be converted, and is in the same ownership as the application site.
- 22 The northern elevation looks directly on to Clock Tower View, and the proposed public open space, and therefore no amenity issues are raised.

Occupier Amenity

- 23 The principle of basement flats has been previously agreed to at block 1 (Clock Tower) and at block 17 (adj. To Stream Road) and therefore it would be unreasonable to take a contrary view in this instance. The lighting and ventilation to these flats would be via light wells as used on two other buildings, including the adjoining clock tower building.

- 24 Not all of the proposed flats would have access to private gardens. However, they would be able to make use of the proposed open space to the north of Clock Tower View. In addition the proposed flats, all of which would have only one-bedroom are less likely to be occupied by families.

Access and parking

- 25 The adopted parking standards requires one space per one bedroom dwelling (11 spaces), and three visitor spaces (1 per 5 dwellings). In this case 17 spaces are proposed are slightly higher than the adopted standards. Seven of these spaces would be served from the private derive, which is an increase in one from the previous approved application,
- 26 The Group Engineer (Development) makes reference to the remoteness of some of the parking, in that not all of the proposed apartments would have direct surveillance over the parking area. However whilst such an arrangement would be desirable it is not possible in this instance as the siting of the building and the proposed parking spaces are fixed as the proposal is for a conversion rather than a new building. In addition it is considered that there would sufficient natural surveillance of the parking area from the other apartments, and the houses adjoining the site, which is in accordance with the advice within the Design for Community Safety Supplementary Planning Guidance. It should be noted that West Midlands Police have not raised an objection in respect of the parking area subject suitable lighting, and that planting is positioned carefully.
- 27 In conclusion, the comments of the Group Engineer (Development) are noted, however, on the basis the car parking proposed exceeds the adopted standards and are not located as to be isolated from the building and benefiting from natural surveillance any parking or highway refusal could not be substantiated in this case.

28 The neighbours to the site make reference to maintenance of the private drive. This is considered to be a private ownership matter outside the planning process. In addition the approved plans to P06/1640 show parking served off the private drive.

Planning Obligations

29 The Black Country Core Strategy Policy DEL1 'Infrastructure Provision' sets out the adopted policy framework for Planning Obligations within Dudley and the Planning Obligations SPD provides further detail on the implementation of this policy; these policy documents were prepared in accordance with national legislation and guidance on planning obligations.

30 Policy DEL1 requires all new developments to be supported by sufficient on and off-site infrastructure to serve the development, mitigate its impact on the environment, and ensure that the development is sustainable and contributes to the proper planning of the wider area.

31 In addition to applying Policy DEL1 and the SPD, in identifying the required planning obligations on this application the following three tests as set out in the CIL Regulations (April 2010), in particular Regulation 122, have been applied to ensure that the application is treated on its own merits:

- (a) necessary to make the development acceptable in planning terms;
- (b) directly related to the development;
- (c) fairly and reasonably related in scale and kind to the development.

32 In consideration of the above the required Planning Obligations on this application have been identified as follows:

- Economic and Community Development
- Public Art
- Public Realm
- Public Open space

- Transport Infrastructure Improvements

- 33 No obligations were required in connection with highway infrastructure improvements in that no relevant scheme has been identified by the Group Engineer (Development). Similarly no scheme was put forward by the relevant service area for public open space or public realm enhancement, and therefore it is not reasonable to request these obligations in this case.
- 34 Contributions requested by the Head of Environmental Health and Trading Standards were to pool monies towards an education campaign on air quality. However, this is not considered to meet the above three tests. The provision of on-site charging point as an alternative would be out of scale and kind, but also would be inoperable, as the spaces may not necessarily be allocated.
- 35 Public art provision is considered to be reasonable request in that it can be provided in a manner which can be incorporated in boundary treatment or surfacing material to the parking areas.
- 36 In respect of Economic and Community Development it does not require the applicant to provide any financial contribution, and just requires the developer to use best endeavours to employ people locally or make use of local materials.
- 37 Obligations were not required towards education in that the development is for one bedroom dwellings only.

CONCLUSION

- 38 The proposed development is acceptable in principle and provides a positive solution to retain and reuse a building which is within a conservation area and is of local architectural interest. The proposed alterations are considered to be acceptable in design terms would cause no harm to neighbour amenity. Consideration has been given to saved policies DD1 Urban Design DD4 Development in Residential Areas DD8 Provision of Open Space, Sport and Recreation Facilities DD10 Nature Conservation LR1 Open Space LR3 Children's

Play Areas NC1 Biodiversity NC6 Wildlife Species NC9 Mature Trees HE4 Conservation Areas and HE5 Buildings of Local Historic Importance of the Dudley Unitary Development Plan and policies CSP2 Development Outside the Growth Network CSP4 Place Making DEL1 Infrastructure Provision HOU1 Delivering Sustainable Housing Growth HOU2 Housing Density, Type and Accessibility ENV 1 Nature Conservation ENV 2 Historic Character and Local Distinctiveness and ENV 3 Design Quality of the Black Country Core Strategy.

RECOMMENDATION

That planning permission is GRANTED subject to the following conditions:

Reason for approval

The proposed development is acceptable in principle and provides a positive solution to retain and reuse a building which is within a conservation area and is of local architectural interest. The proposed alterations are considered to be acceptable in design terms would cause no harm to neighbour amenity. Consideration has been given to saved policies DD1 Urban Design DD4 Development in Residential Areas DD8 Provision of Open Space, Sport and Recreation Facilities DD10 Nature Conservation LR1 Open Space LR3 Children's Play Areas NC1 Biodiversity NC6 Wildlife Species NC9 Mature Trees HE4 Conservation Areas and HE5 Buildings of Local Historic Importance of the Dudley Unitary Development Plan and policies CSP2 Development Outside the Growth Network CSP4 Place Making DEL1 Infrastructure Provision HOU1 Delivering Sustainable Housing Growth HOU2 Housing Density, Type and Accessibility ENV 1 Nature Conservation ENV 2 Historic Character and Local Distinctiveness and ENV 3 Design Quality of the Black Country Core Strategy.

The decision to grant planning permission has been taken with regard to the policies and proposals in the adopted Dudley UDP (2005) and to all other relevant material considerations.

The above is intended as a summary of the reasons for the grant of planning permission. For further detail on the decision please see the application report.

Conditions and/or reasons:

1. The development hereby permitted shall be begun before the expiration of three years from the date of this permission.
2. Prior to the commencement of development precise details of the colour finish shall be submitted to and approved in writing by the Local Planning Authority. The window surrounds and joinery shall be finished in accordance with the approved details and shall be retained in that colour for the life of the development.
3. No development shall commence until large scale details of all new window and door joinery, including surrounds and cills and the floor transition points of the windows, have been submitted to and approved in writing by the Local Planning Authority. The new window and door joinery, including surrounds and cills and the floor transition points of the windows shall thereafter be finished in accordance with the approved details and shall be retained for the life of the development.
4. No development shall be commenced until large scale details of the rooflights have been submitted to and approved in writing by the Local Planning Authority. The roof lights shall thereafter be provided in accordance with the approved details.
5. The materials to be used in the construction of the of the development hereby permitted shall match those used in the existing building.
6. No works the subject of this consent shall be commenced until a schedule of repairs to the chimney has been submitted to and approved in writing by the Local Planning Authority. The repairs approved the Local Planning Authority as listed in the approved schedule shall be completed prior to any of the dwellings being first occupied.
7. No part of the development hereby permitted shall be commenced until full details of soft landscaping works have been submitted to and approved in writing by the Local Planning Authority. These details must include, where appropriate, planting plans, written specifications, a schedule of plants including species, plant sizes and proposed numbers/densities and a programme of implementation. Plans must also include accurate plotting of all existing landscape features.

The works approved as part of this condition shall be completed within the first planting season following the first occupation of any part of the development.

Any trees or shrubs planted in pursuance of this permission including any planting in replacement for it which is removed, uprooted, severely damaged, destroyed or dies within a period of five years from the date of planting shall be replaced by trees or shrubs of the same size and species and in the same place unless otherwise agreed in writing by the Local Planning Authority.

8. No part of the development hereby permitted shall be commenced until a schedule of landscape maintenance, including details of its implementation for a minimum period of five years from first planting has been submitted to and approved in writing by the District Planning Authority.

9. No part of the development hereby permitted shall be commenced until details of the positions, design, materials and type of boundary treatment or means of enclosure have been submitted to and approved in writing by the Local Planning Authority. No part of the development shall be occupied until these works have been carried out in accordance with the approved details.
10. No part of the development hereby permitted shall be commenced until full details of hard landscape works, public realm works and on site public art have been submitted to and approved in writing by the District Planning Authority. The details must include existing and proposed finished levels or contours; the position, design and materials of all site enclosures, car parking layout and other vehicular and pedestrian areas; hard surfacing materials, minor artefacts and structures (e.g. street furniture, play equipment, refuse areas, lighting etc;) and any retained historic features and proposals for restoration.

The works approved as part of this condition shall be completed before the first occupation of any part of the development and retained for the life of the development.

11. None of the development hereby approved shall be first occupied until the parking areas have been laid out and provided in accordance with the approved details. The parking areas shall thereafter be retained for the life of the development.
12. The first floor window to the landing area to flats 9 and 11, as well as the first floor kitchen/living dining room window to the south elevation of flat 11 shall be fitted with obscured glazing which shall be retained for the life of the development.
13. Notwithstanding the provisions of the Town and Country Planning (General Permitted Development) Order 1995 (or any Order revoking or re-enacting that Order with or without modification) no development covered by Part 25 and/or Part 40 of Schedule 2 to that Order shall be carried out without planning permission granted by the Local Planning Authority.
14. No development hereby permitted shall be commenced (except for demolition) until a scheme to deal with contamination of land (including soil gases and vapours) has been submitted to and approved in writing by the local planning authority. The measures within the agreed scheme shall be fully implemented. The scheme shall include all of the following measures unless the local planning authority dispenses with any such requirement specifically in writing:
 - i) a desk-top study to formulate a conceptual model of the site. The requirements of the local planning authority shall be fully established before the desk-study is commenced; and
 - ii) once the desk study has been approved by the local planning authority, a site investigation shall be carried out to identify and evaluate all potential sources and impacts of identified contamination in accordance with the conceptual model. The findings of the site investigation shall be presented in a report for approval by the local planning authority and shall include a risk-based interpretation of any identified contaminants in line with uk guidance; and
 - iii) following the approval of both desk-top study and site investigation reports, a written remediation scheme and method statement (the contamination proposals) shall be agreed in writing with the local planning authority prior to commencement. The contamination proposals shall be implemented in full and no deviation shall be

made form the contamination proposals without the express written permission of the local planning authority. The contamination proposals shall include a validation scheme and validation criteria for the use of imported material and reuse of site-won materials; provisions for validation monitoring and sampling to demonstrate completion; and be retained throughout the lifetime of the development.

lv) if during development works any contamination should be encountered which was not previously identified or is derived from a different source and/or of a different type to those considered under the contamination proposals then the local planning authority should be notified immediately and remediation proposals formulated/amended for consideration. All works must cease until these measures are agreed in writing by the local planning authority and the development shall recommence in accordance with the agreed details.

V) if during development work, contaminants are found in areas previously expected to be acceptable, then the local planning authority should be notified immediately and remediation proposals formulated/amended for consideration. All works must cease within the relevant phase until these measures are agreed in writing by the local planning authority and the development shall recommence in accordance with the agreed details.

15. A scheme detailing the developer's commitment towards economic and community development through job opportunities using locally sourced labour and materials for the implementation of the development hereby approved shall be submitted to, and approved in writing by, the LPA prior to the commencement of works. Development shall be implemented in accordance with the approved details, unless otherwise agreed in writing by the LPA.
16. The development hereby permitted shall be carried out in accordance with the following approved plans: WH/1003i WHP32 WHP31b

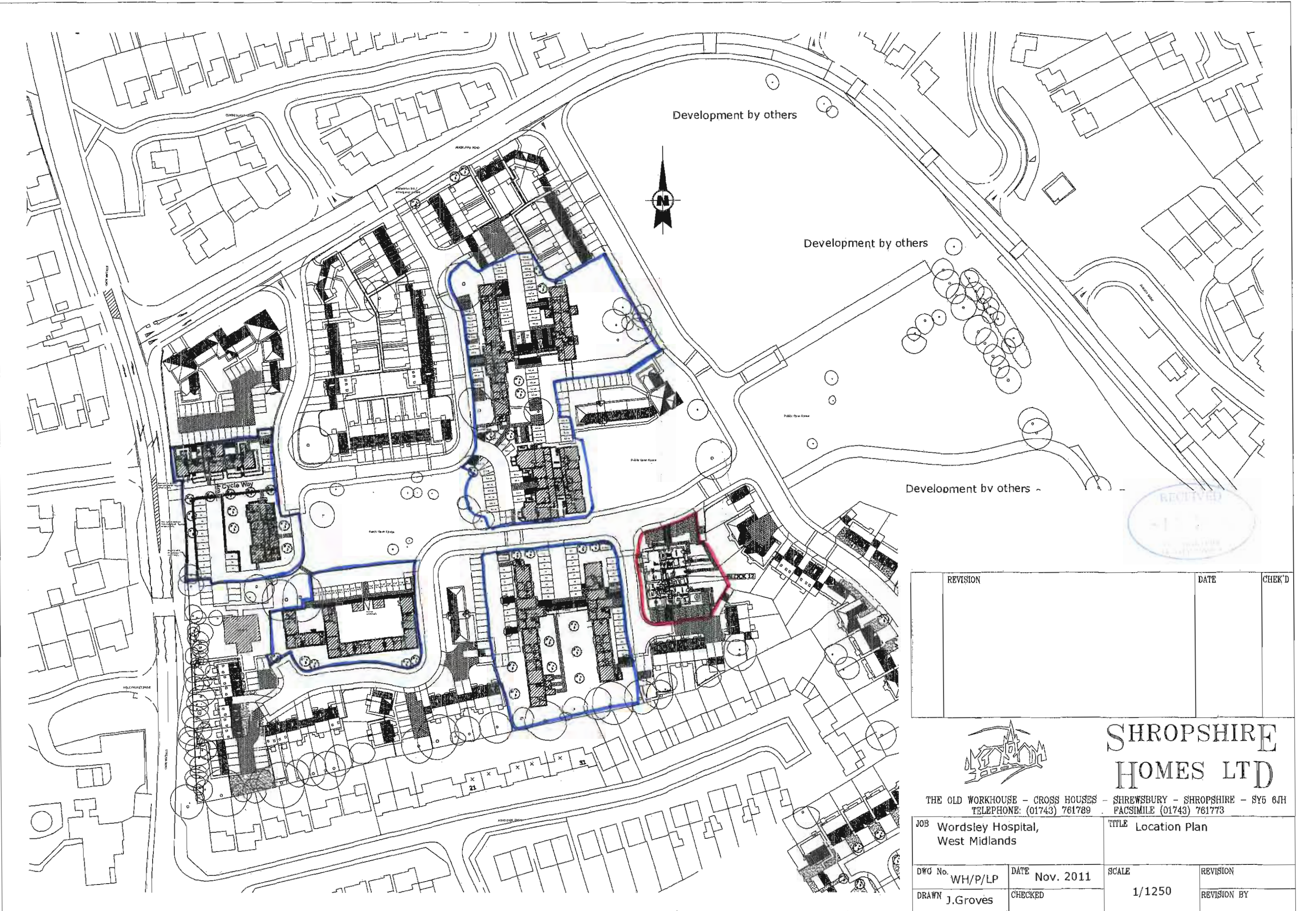

REVISION	DATE	CHEK'D



SHROPSHIRE HOMES LTD

THE OLD WORKHOUSE - CROSS HOUSES - SHREWSBURY - SHROPSHIRE - SY5 6JH
 TELEPHONE: (01743) 761789 FACSIMILE (01743) 761773

JOB Wordsley Hospital, West Midlands		TITLE Location Plan	
DWG No. WH/P/LP	DATE Nov. 2011	SCALE 1/1250	REVISION
DRAWN J.Groves	CHECKED		REVISION BY

PLASTER (AI)

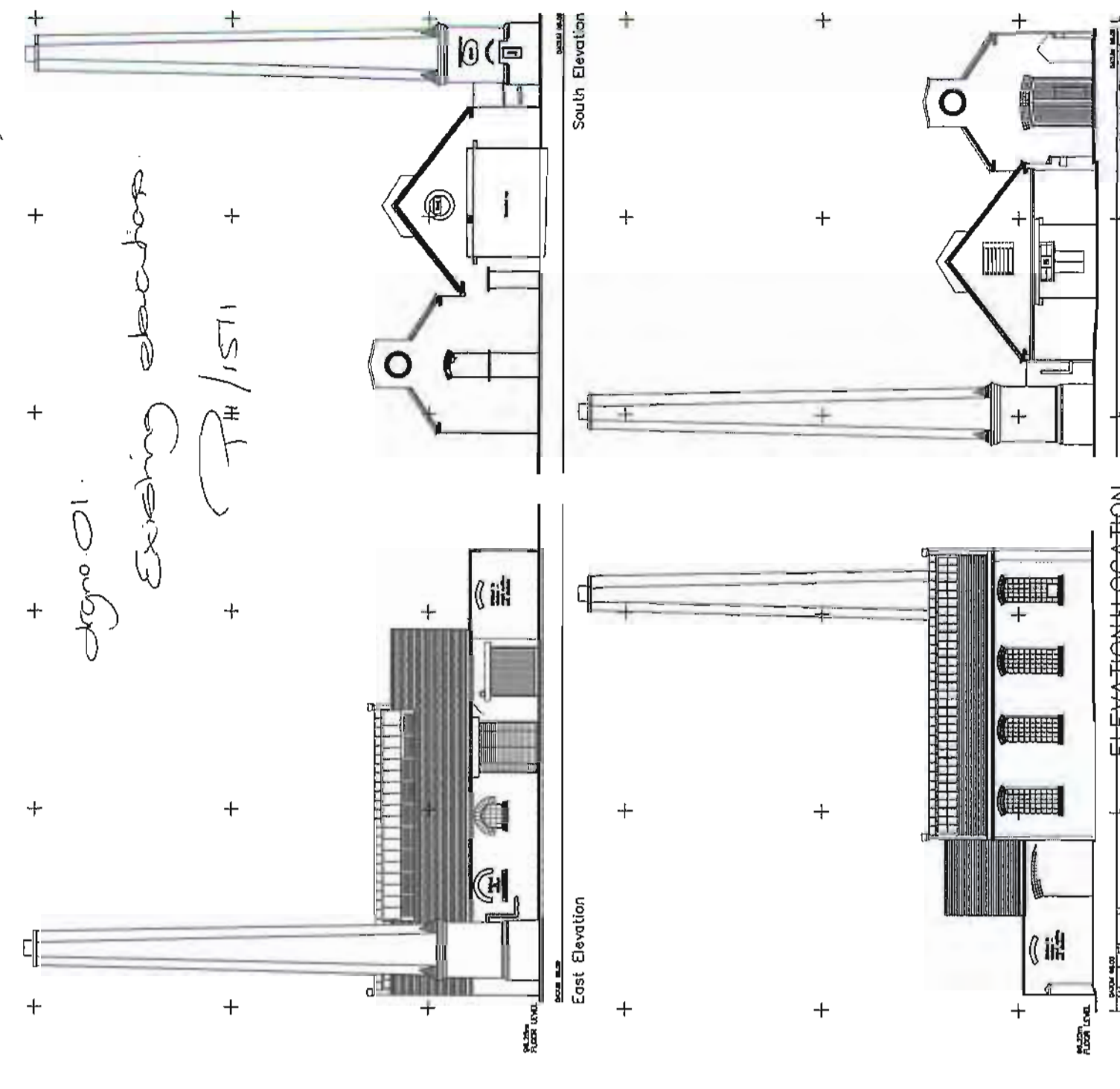

dyo 01.
Existing elevation
P#1/ST1

Legend

DP DRAIN PIPE
VP VENT PIPE
WP WASTE PIPE

Notes
COPYRIGHT FOR DRAWING REMAINS WITH BARRY LOWE SURVEYS, AND MAY NOT BE COPIED WITHOUT THEIR WRITTEN CONSENT.

BARRY LOWE SURVEYS LTD CHASTERTON ROAD BATSFIELD ENTERPRISE PARK SHROPSHIRE SY1 3EH TEL/FAX 01743 443388		RICS REMOVED ELEVATIONS BLOCK TWELVE WORDSWLEY HOSPITAL	
Client	SHROPSHIRE HOMES	Title	REMOVED ELEVATIONS
Scale	1:100	Date	30/03/11
Job No	8123	Dwg No	01
Surveys by	JCP/EF	Checked	JCP
Scanned	JCP	NO	NO
Levels are related to	SITE DATUM (OS)		

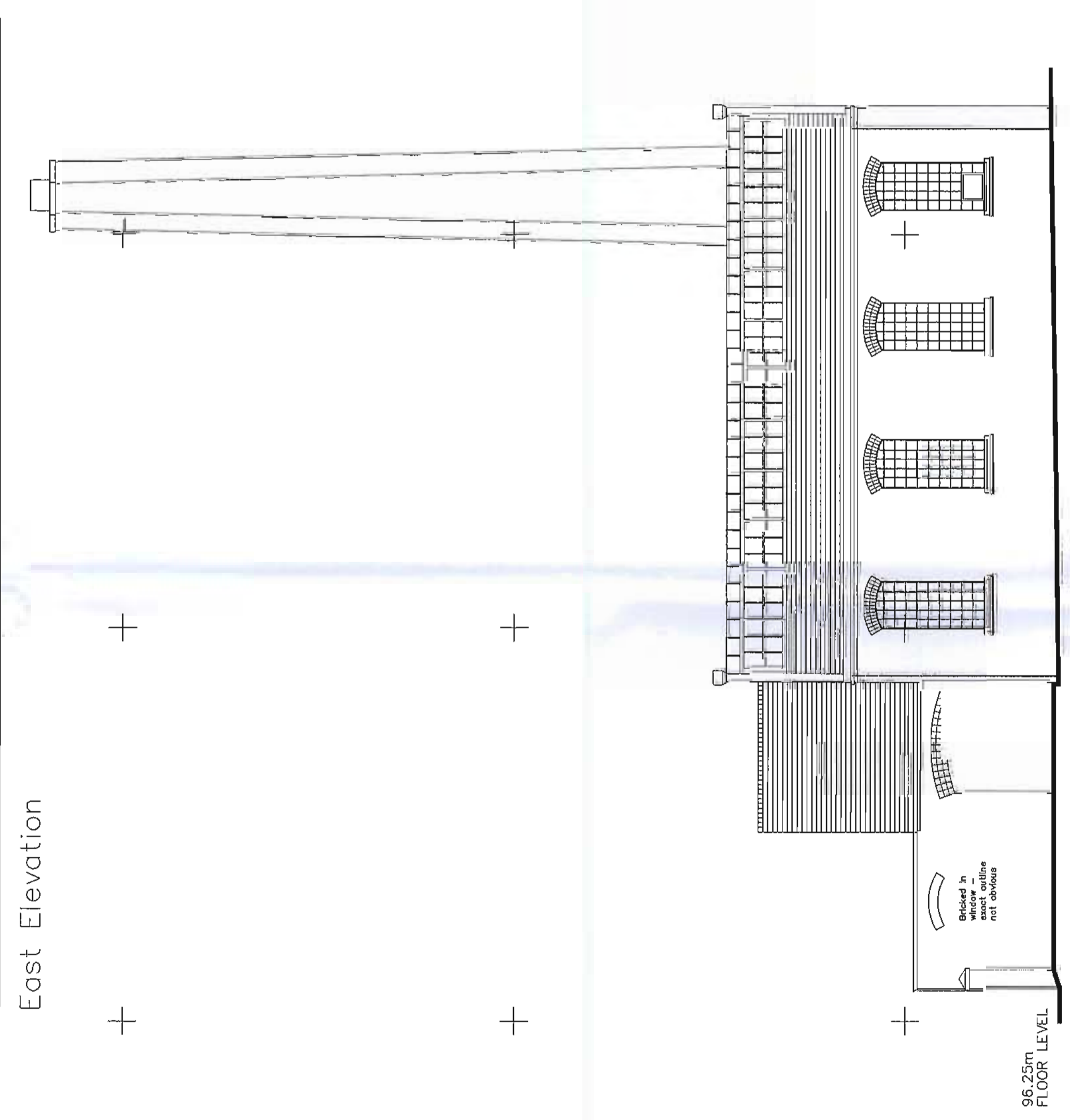
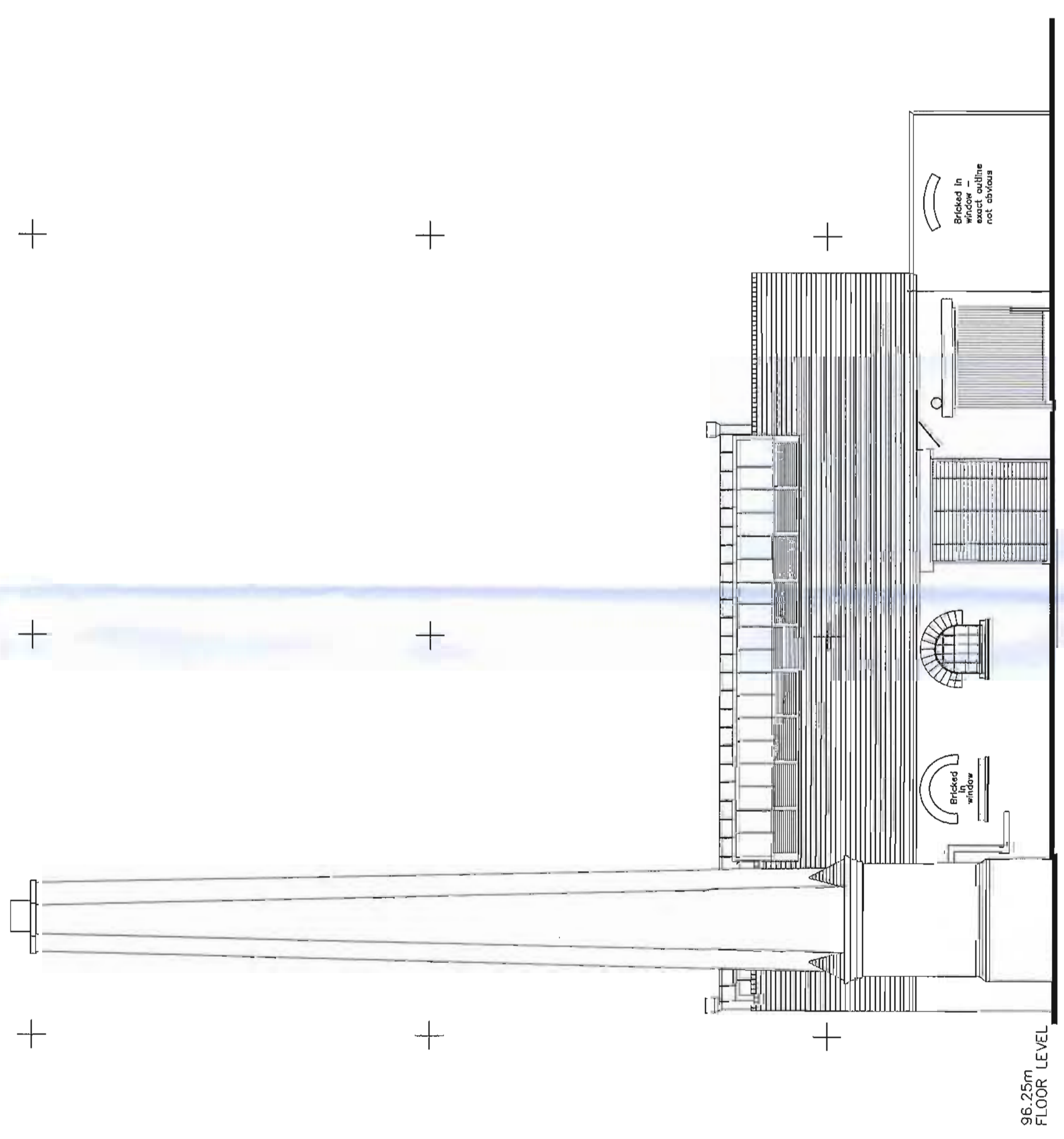
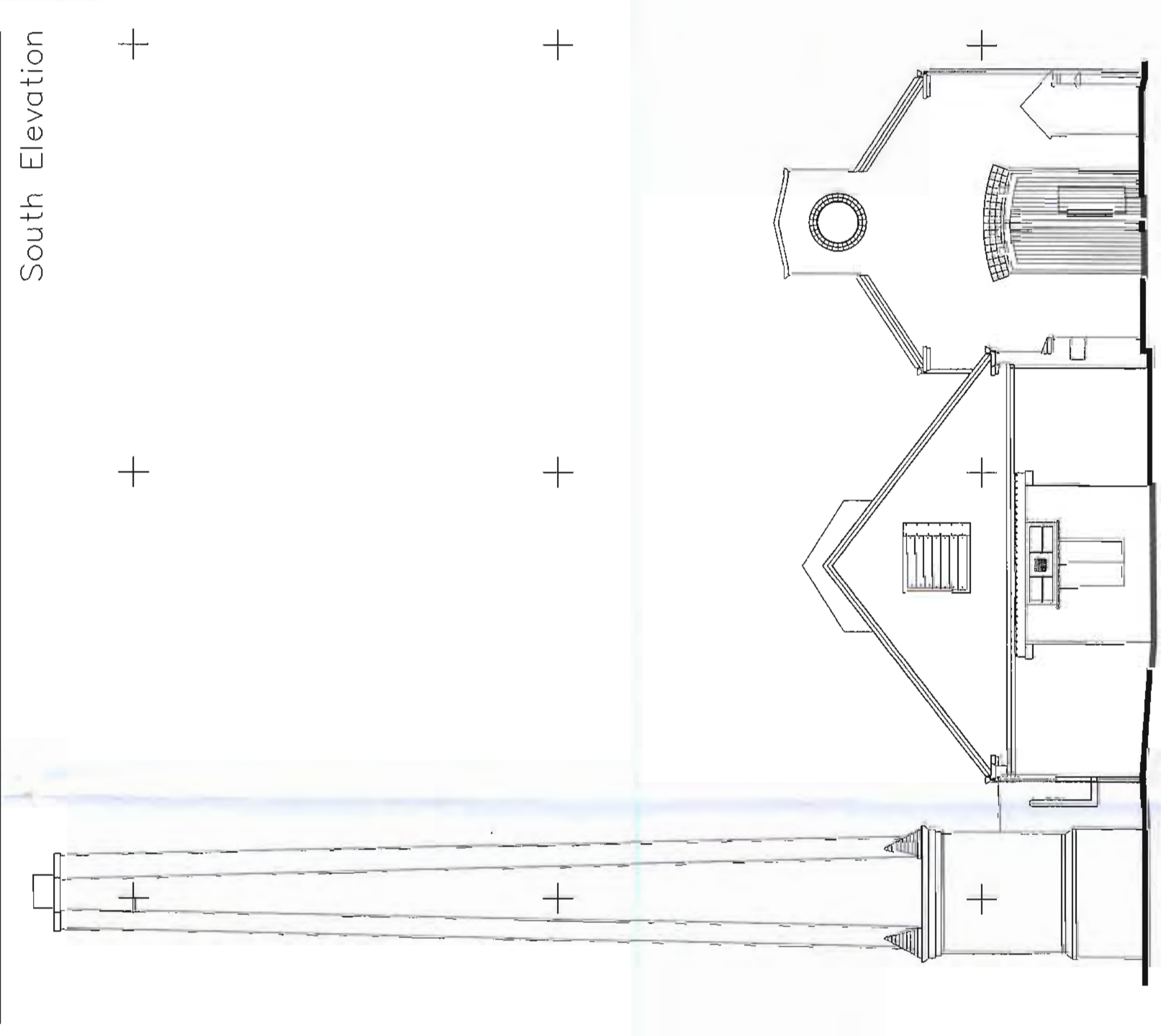
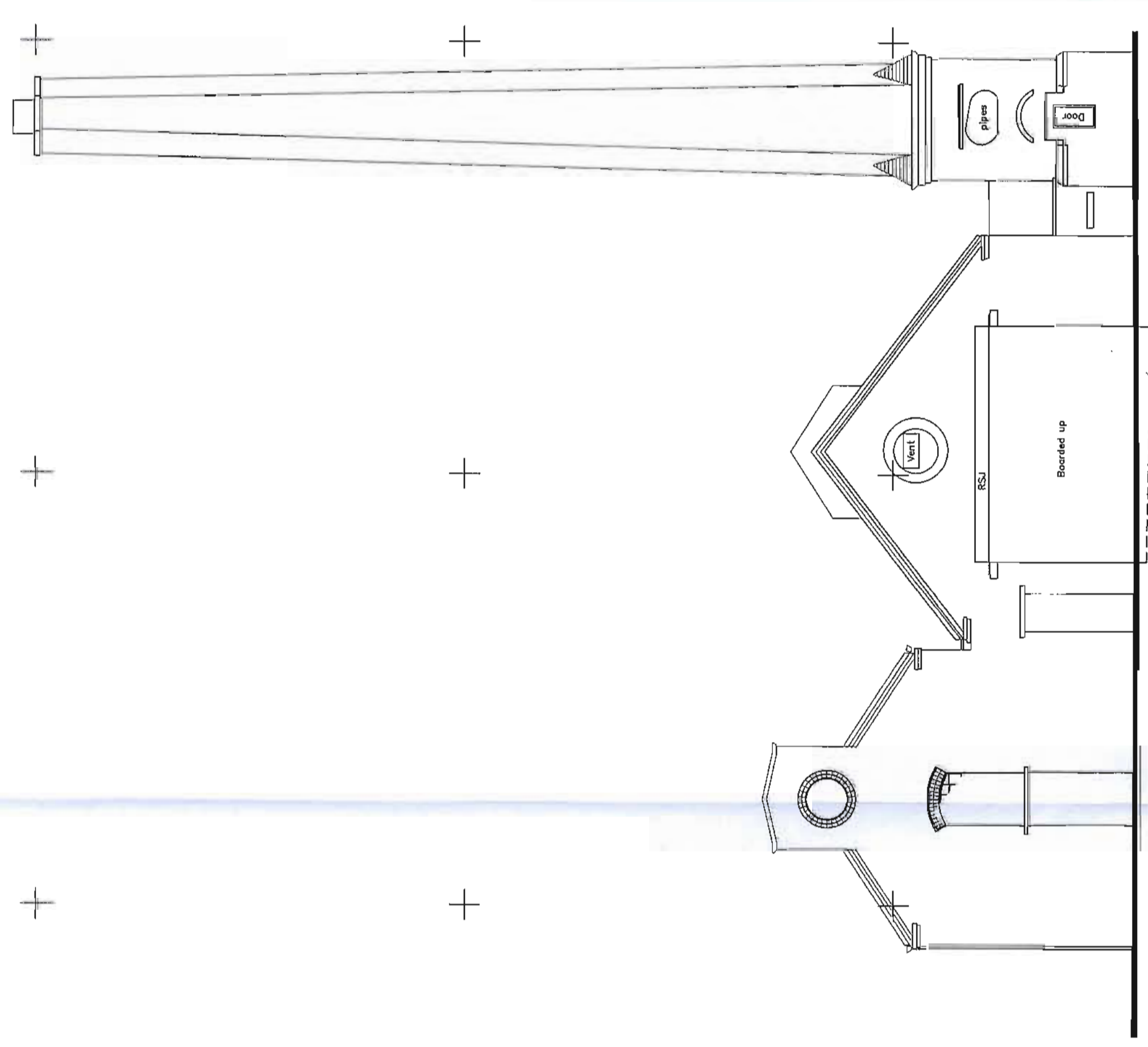

GA1
 Dec 2011
 DWG NO. WH/1003
 Proposed site layout
 Plan
 P.1/1511



**SHROPSHIRE
 HOMES LTD**

THE OLD WORKHOUSE - CROSS HOUSES - SHROPSHIRE - ST6 4HT
 TELEPHONE: (01743) 781789
 FACSIMILE: (01743) 781773

PROJECT: Proposed Site Plan -
 Block 12

DWG NO: WH/1003
 DATE: Nov '11
 CHECKED BY: DAVID J. GROVES
 SCALE: 1/200
 REVISION BY: []



DEVELOP. (A1)
 Dwg. no. W.H.P. 32.
 Proposed elevations.
 21/1/11



REVISION	DATE	BY
A	15.06.11	
B	27.09.11	
C	30.11.11	

SHROPSHIRE HOMES LTD

THE OLD WORKHOUSE - CROSS FIELDS - STURROPSHIRE - ST5 6BE
 JOB No. W.H.P. 32
 TITLE Block 12 - Elevations
 SCALE 1/100
 DRAWN J.G.
 CHECKED
 REVISIONS C

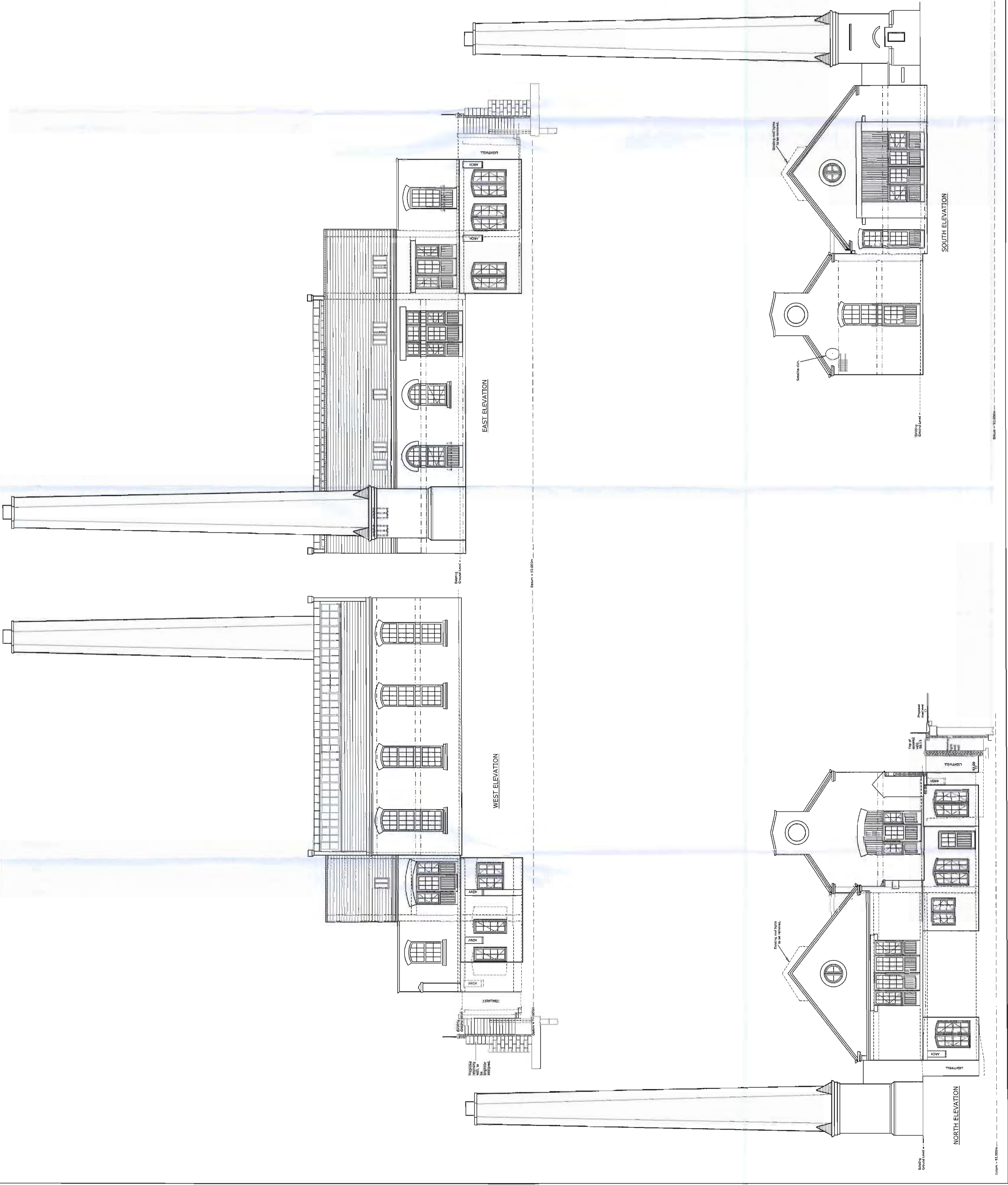

DECLASSIFIED
 BY: 2393 OI, 22/06/01
 Existing classification: 

R.1/1511

Figured dimensions only to be taken from this drawing. Measurements checked on site and any discrepancies should be reported immediately.

REVISIONS
 Rev A D.W.P.
 18.04.05
 Checked on site and measured on South and North elevations. amended schedule to rev of East elevation added. Verifying added to East elevation.

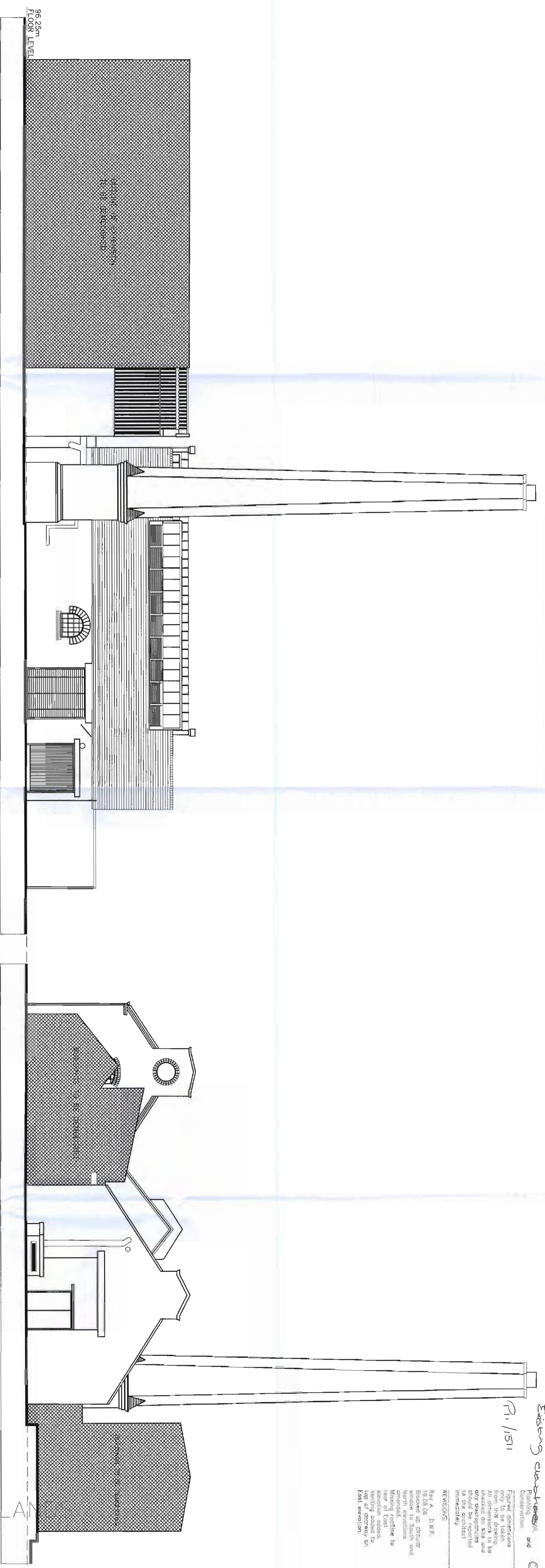

East Elevation

South Elevation

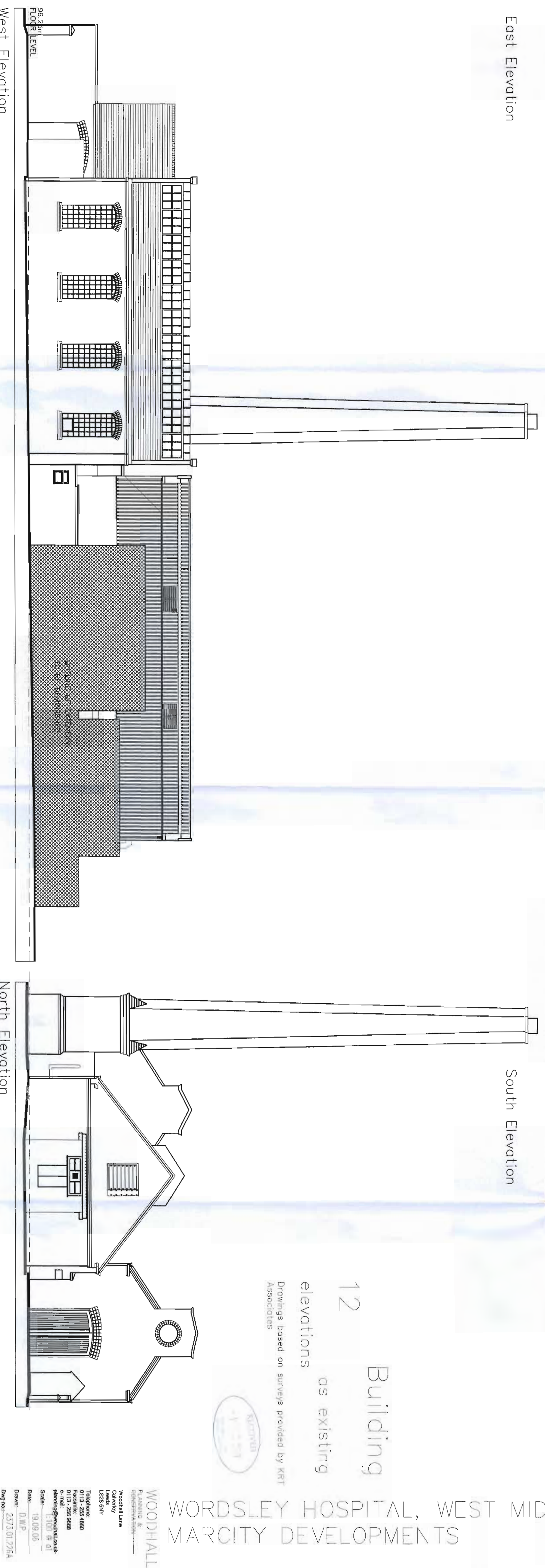

West Elevation

North Elevation

12 Building
 elevations
 as existing
 Drawings based on surveys provided by KRT Associates



WOODHALL
 PLANNING & CONSULTANCY
 Woodhall Lane
 Colverley
 LS20 5WY
 Telephone: 0113 255 8890
 Fax: 0113 255 8888
 e-mail: planning@woodhall.co.uk
 Website: www.woodhall.co.uk
 Scale: 1:100 @ 31
 Date: 19.09.05
 Drawn: D.W.P.
 Drawing: 2373.01.226A

WORDSLEY HOSPITAL, WEST MIDLANDS
 MARCITY DEVELOPMENTS

