

# PLANNING APPLICATION NUMBER:P12/0462

Type of approval sought	Full Planning Permission
Ward	Lye and Stourbridge North
Applicant	Ms Julie Gunning, NHS Dudley Primary Care Trust
Location:	<b>VACANT LAND BETWEEN JACKSON STREET &amp; CLINIC DRIVE, LYE, STOURBRIDGE, WEST MIDLANDS</b>
Proposal	<b>ERECTION OF NEW HEALTH CENTRE TO INCLUDE A RETAIL PHARMACY AND ASSOCIATED CAR PARKING</b>
Recommendation Summary:	<b>APPROVE SUBJECT TO A 106 AGREEMENT</b>

## SITE AND SURROUNDINGS

1. The application site measures approximately 0.28 hectares in area and is bounded on three sides by public highways; to the north by the A458, Lye By-Pass, to the East by Clinic Drive and to the West by Jackson Street. Lye By-Pass and Clinic Drive are both one-way and the former is part of the transport corridor which links Stourbridge, Halesowen and Birmingham. Jackson Street is partly one and two way from the High Street and Lye Bye- Pass to enable access and egress from Jackson Street car park. The by-pass runs west to east, with Clinic Drive and Jackson Street running south and north respectively, connecting Lye High Street to the By- Pass. The South side of the site is bounded by a number of rear gardens / yards relating to properties fronting the High Street.
2. The site relates to the Orchard Lane Car Park and is previously developed land or a 'Brown field' site located to the north of Lye Town Centre surrounded in the main by commercial properties. Historically the site was recorded as being occupied by a number of domestic or commercial properties fronting out onto what is now the Lye By-pass.

3. The site is subject to subsoil contamination by its previous uses and from fly tipping. The site is also affected by a large spread of Japanese Knotweed, which would require treatment / removal before development could begin. The site is also populated by a number of mature and semi mature trees.
4. The site slopes downwards from the east to the west by approximately 4 metres in total with the gradient across the site evident from the By Pass.

## PROPOSAL

5. The application seeks full planning permission for the erection of a three storey medical centre. The proposed building is to be used to accommodate the relocation of two local GP practices (The Limes and Pedmore Road) and Primary Care Services (including a pharmacy) over a gross floor area of 2657sq. metres.
6. The scheme would accommodate soft and hard landscaping and provide approximately 25 car parking spaces on two gated car parks located to each end of the site. The 'Staff' car park would provide 14 no. parking spaces and would be accessed via Jackson Street. Within this parking area, provision would be made for a visiting 'mobile' Screening unit which would also utilise a turning area on Jackson Street car park opposite; however, it should be noted that this facility is only expected to be used once or twice every 3 years.
7. The 'patients' car park would provide approximately 10 no. parking spaces (with the majority being marked or unmarked disabled parking bay spaces) and would be accessed via a barrier arm gate from Clinic Drive which would link to the first floor of the development due to the level change across the site.
8. The expected opening hours would be 07:00 to 20:00 (Monday to Friday) and 08:00 to 10:00 (Saturday) and closed Sunday and Bank Holidays. The applicant also expects 36 full time people would be employed (21 medical staff and 15 non-medical staff).

9. The application is accompanied by the following information:

- Planning Statement
- Design and Access Statement
- Air Quality Assessment
- Tree Assessment
- Ecological Appraisal
- Accessibility Report
- Japanese Knotweed Report
- Geo-environmental Assessment
- Transport Assessment
- Travel Plan Framework
- Parking Strategy

## HISTORY

### Application Site

APPLICATION	PROPOSAL	DECISION	DATE
93/51619	Full planning permission for the construction of a single carriageway bypass to the north of Lye town centre between cemetery road and Hayes Lane	Approved With conditions	13 January 1994

## PUBLIC CONSULTATION

10. The application was advertised by way of neighbour notification letters being sent to the occupiers of 180 properties within the vicinity of the site, by the display of a site notice and by an advert within the local press. Two objections were received expressing concern to the impact the development would have upon prescriptive rights of way / servicing of vehicles, as well as land ownership. Amended plans were received, resulting in further neighbour notification letters being sent to the same occupiers. The latest date for comments was the 26 November 2012, with no further representations being received.

## OTHER CONSULTATION

11. Group Engineer (Development): No objection raised subject to highway conditions (including a travel plan) and the applicant entering into Section 38 and Section 278 agreements under the Highway Act 1980 to allow for highway works to include a new widened footway in clinic drive and new footways in Jackson Street to an adoptable highway standard. The existing footways in Jackson Street shall also be improved to a carriageway construction specification to be able to withstand loads from large articulated vehicles.

The Group Engineer (Development) advises that the targets for the Travel Plan should be no more than 900 average daily vehicle movements or 10% reduction in vehicle movements (whichever is the lesser), as measured by the initial post development opening vehicle survey which should be undertaken within 3 months of the first occupation of the building. This target should be attained within 5 years of first occupation.

12. Head of Environmental Health and Trading Standards: The air quality assessment concludes that there will be small but insignificant air quality impacts resulting from traffic increases on the local network. To combat the synergic air quality impacts of developments of this type due to an increase in trip generation a condition is recommended for the onsite provision of charging points for electric vehicles (Condition 7). Additionally, to ensure that any noise from fixed plant such as air condition systems would not lead to a loss of amenity a noise condition should be included (Condition 10).
13. Severn Trent Water: No objection raised subject to a condition (Condition 8) to ensure satisfactory drainage plans for the disposal of surface water and foul sewage.

14. Coal Authority: The Coal Authority considers that the content and conclusions of the Geo-environmental Assessment are sufficient for the purposes of the planning system and meet the requirements of the National Planning Policy framework (NPPF) in demonstrating that the application site is, or can be made, safe and stable for the proposed development. The Coal Authority therefore raises no objection to the development subject to the imposition of a condition (Condition 9) requiring intrusive site investigation works as recommended within the Geo-environmental Assessment are undertaken prior to commencement of development.
15. West Midlands Police: No objection raised; however a number of detailed observations are suggested relative to the operation of the site.
16. West Midlands Fire Service: No objection raised as scheme would be satisfactory for fire service access

## RELEVANT PLANNING POLICY

### National Planning Guidance

- National Planning Policy Framework (NPPF) (2012)

### Black Country Core Strategy (BCCS) (2011)

- The Vision
- Sustainability Principles
- The Spatial Objectives
- CSP1 The Growth Network
- CSP4 Place Making
- CSP5 Transport Strategy
- DEL1 Infrastructure Provision
- HOU5 Education and Health Care Facilities
- CEN1 The Importance of the Black Country Centres for the Regeneration Strategy
- CEN2 Hierarchy of Centres
- CEN6 Meeting Local Needs for Shopping and Services

- CEN8 Car Parking in Centres
- TRAN2 Managing Transport Impacts of New Development
- ENV 1 Nature Conservation
- ENV 3 Design Quality
- ENV 5 Flood Risk, Sustainable Drainage Systems and Urban Heat Island
- ENV 7 Renewable Energy
- ENV 8 Air Quality

#### Saved Unitary Development Plan (UDP) Policies (2005)

- DD1 Urban Design
- DD2 Mixed Use
- DD3 Design of Retail Development
- DD9 Public Art
- DD10 Nature Conservation and Development
- UR9 Contaminated Land
- CS3 Community Facilities
- NC1 Biodiversity
- NC6 Wildlife Species
- NC9 Mature Trees
- NC10 The Urban Forest
- EP3 Water Protection
- EP6 Light Pollution
- EP7 Noise Pollution

#### Supplementary Planning Documents (SPD)

- Nature Conservation
- Parking Standards
- Planning Obligations

#### Supplementary Planning Guidance (SPG)

- Design for Community Safety

## ASSESSMENT

17. The determining issues in the assessment of this application are the:

- Principle
- Impact on the character of the area
- Highway Issues
- Nature Conservation
- Planning Obligations

### Principle

18. The National Planning Policy Framework (NPPF) states that the purpose of the planning system is to contribute to the achievement of sustainable development and that this can be achieved, in part, by providing support for healthy communities and accessible local services, which reflect the community's needs and support its health, social and cultural well-being. The NPPF also promotes the provision of mixed use developments as one of its 12 core planning principles, as does Policy HOU5 (Education and Health Care Facilities) of the Black Country Core Strategy (BCCS), which supports the provision of a mix of compatible community service uses on a single site. Saved Policy DD2 (Mixed Use) of the Dudley Unitary Development Plan also encourages mixed use developments as a key component of the vitality and viability of local areas.
19. The application site constitutes previously developed land ('brown field') within a highly sustainable district centre location served by a number public transport routes (including bus and rail). The health care facility would allow for the re-location of the existing Limes and Pedmore Road GP Practices to form a hub of GP services alongside specialist primary care services including a Pharmacy, offices and a community room. In addition to health care facilities, it also includes a community

room, library and seminar rooms thereby, providing a number of uses in the local centre within one building. The development is therefore considered to be acceptable in principle with regard to the above NPPF advice and Policy HOU5 of the BCCS and Saved Policy DD2 of the Dudley UDP.

20. Policy HOU5 of the BCCS also requires that new health care facilities should be well related to public transport infrastructure and directed to a centre appropriate in role and scale to the proposed development and its catchment area. It is considered that the site is ideally located to serve the local Lye community, as it is within walking distance of residential properties, has bus stops within close proximity (on the highway frontage), as well as the nearby train station, to the north of the site. In this respect the proposal also complies with Policy CSP4 (Place Making) of the BCCS which advises that centres should provide a focus and concentration for essential local services with easy access by walking, cycling and public transport.

#### Impact on the Character of the Area

21. A contemporary approach has been taken towards the design and appearance of the building, which would deliver a distinctive statement to building that hares design elements with the 'sure start' development to the east.
22. The building would be flat roofed and of a maximum of three storeys in height with white and green render to create a modern façade complimented by traditional red brick, located at back of pavement to ensure that it would have a strong and active street frontage. The Clinic Drive and Jackson Street frontages would be denoted by brick walls with railings over, denoting the public and private realms. The development would make a positive contribution to the character of the area. In this respect the proposal complies with:
  - The NPPF, which advises that in determining applications great weight should be given to outstanding or innovative designs which help raise the standard of design more generally in the area;



- Policy ENV3 (Design Quality) of the BCCS which seeks to deliver a successful urban renaissance through high quality design;
- Saved Policy DD1 (Urban Design) of the UDP which requires that new developments should make a positive contribution to the character and appearance of the area.

### Highway Issues

23. Policy TRAN 2 (Managing Transport Impacts of New Development) of the BCCS requires that new developments should demonstrate their travel and transportation impacts together with proposals for mitigation, and advises that it is important that accessibility by a choice of sustainable modes of transport is maximized at all developments.
24. To accord with the standards set out in the Parking Standards Supplementary Planning Document (SPD) for medical facilities (1 space per member of staff and 2 spaces per treatment room) the development should provide a maximum of 82 parking spaces; however, in this instance approximately 25 parking spaces are to be provided which would result in a shortfall of some 50 parking spaces from the maximum standards but given that there is additional capacity in adjacent 'public' car parks, this shortfall would be accommodated. It should also be considered that the site lies in a sustainable location near to public transport nodes. The choice of transport modes available to patients and staff (walking, car, cycle, and public transport) would therefore ensure the accessibility of the site in accordance with Policy TRAN2 of the BCCS.
25. With regard to the comments of the Group Engineer it is recommended that a condition be imposed requiring the submission of a delivery management strategy, in order to prescribe the types of vehicle allowed to visit the site, the means by which they gain access to the site, and the hours during which they can visit. The imposition of such a condition would ensure that the development would not prejudice highway safety implications. This shall be secured by condition (Condition 6)

### Nature Conservation

26. The Ecology Appraisal by FPCR Environment and Design Ltd, dated September 2010, confirms that there are no likely impacts upon protected species, accordingly the proposal is supported by nature conservation planning policies and mitigation would be secured through on site mitigation in the form of low-level lighting and the planting of native trees, hedgerows and wild flower planting. Low-level lighting would also be introduced. The scheme would accord with Policy ENV 1 (Nature Conservation) of the BCCS and Saved Policy DD10 (Nature Conservation and Development) and Nature Conservation SPD.

### Planning Obligations

27. Policy DEL1 (Infrastructure Provision) of the BCCS sets out the adopted policy framework for Planning Obligations within Dudley and the Planning Obligations SPD provides further detail on the implementation of this policy; these policy documents were prepared in accordance with national legislation and guidance on planning obligations. Policy DEL1 of the BCCS requires all new developments to be supported by sufficient on and off-site infrastructure to serve the development, mitigate its impact on the environment, and ensure that the development is sustainable and contributes to the proper planning of the wider area.
28. The obligations potentially triggered according to the Planning Obligations SPD are Economic and Community Development, Public Art, Public Realm Improvements, Transport Infrastructure Improvements, Air Quality Improvements and Nature Conservation Improvements. In determining the required planning obligations on this specific application the following three tests as set out in the CIL Regulations, in particular Regulation 122, have been applied to ensure that the application is treated on its own merits:
  - (a) necessary to make the development acceptable in planning terms;
  - (b) directly related to the development;
  - (c) fairly and reasonably related in scale and kind to the development.

29. Following consideration of the above tests the following planning obligations are required for this application:

On-Site Provision (to be secured by condition)

- Economic and Community Benefit – to source local labour and materials to aid stimulus of the both the local economy and employment opportunities and to reduce the carbon footprint of the development by sourcing materials locally and to ensure best fit with the local materials of the surrounding built environment (Condition 11).
- Public Art – 1% of the Design and Build Costs. The public art feature details as submitted (incorporated within the frontage boundary wall treatment) shall be secured by condition (Condition 12).
- Air Quality – to provide an electric vehicle charging point within the development (specifically the staff parking area (Condition 7).
- Nature Conservation – to an equivalent value of £1,456.00; wildflower planting and native hedgerows shall be secured within the soft landscaping by condition (Condition 4) and replacement native trees (Condition 18). Low-level lighting would also be introduced (Condition 19). This would allow the development to make a positive contribution to the natural environment.

30. It is considered that these contributions meet the necessary tests as stated above in that they contribute to the delivery of a sustainable development, are being provided directly on the development site itself and are deemed to be in scale and kind to the proposed development.

31. This development complies with the requirements Policy DEL1 of the BCCS and the Planning Obligations SPD.

## CONCLUSION

32. No significant adverse impacts have been identified but positive impacts would arise in terms of economic, social, environmental and health and wellbeing issues.
33. In terms of economic issues the development would generate economic outputs, physical regeneration and local employment. The development could create 36 jobs for 21 medical staff and 15 non-medical staff. The development would also generate jobs in the construction phase of the development. The medical centre would therefore generate a significant number of new jobs and economic benefits to Dudley, the Black Country and the West Midlands as a whole at a time of high unemployment.
34. The principle of the use of the site as a medical centre accords with the relevant Saved UDP land designation for this part of Lye as the proposal provides a regeneration opportunity to help sustain the town centre as a whole and would help to achieve one of the aims of the NPPF to secure economic growth in order to create jobs and prosperity.
35. The scheme would provide a degree of parking and would be located adjacent to further 'public' car parks to provide other ambulant parking which would support the development. The proposed highway improvement works would ensure that the increased vehicular pedestrian and vehicle generation can also be satisfactorily accommodated. An appropriate amount of additional infrastructure is to be provided to ensure that the development achieves its sustainability objectives.

In terms of social benefits, the development would help to achieve the NPPF aim of supporting the health and social well-being of communities, by creating a high quality built environment within a neglected part of the town centre with no active developed frontage.

36. With respect to the environmental benefits of the scheme the development would contribute to the enhancement of the built environment, having a positive impact on the appearance of the town centre. An appropriate amount of additional infrastructure is to be provided to ensure that the development achieves its sustainability objectives.
37. Finally, there is a positive health and wellbeing impact from the development which would be well linked to the rest of the centre and the wider area, and proposes clear and legible pedestrian routes, active street frontages which can help to create healthy, inclusive communities.
38. The principle of the proposed development on a sustainable 'brown field' site is acceptable in that it would be a mixed use development providing health care and community facilities in a sustainable location within the community it will serve. The proposed development would provide regeneration benefits and apply the principles of good urban design whilst making a positive contribution to the character of the area. The development would also provide satisfactory parking and delivery arrangements whilst having no significant impact upon highway safety.
39. Planning Obligations can be secured by condition with Economic and Community Development, Public Art, Air Quality Improvements and Nature Conservation Improvements being provided on site. On this basis, the development is considered compliant with policy and the associated guidance.

## RECOMMENDATION

40. It is recommended that the application be **approved subject to conditions**:

### Reason for approval

The principle of the proposed development on a sustainable 'brown field' site is acceptable in that it will be a mixed use development providing health care and community facilities in a sustainable location within the community it will serve. The proposed development would make a positive contribution to the character of the area and would have no significant impact upon highway safety.

Planning Obligations can be secured by condition with Economic and Community Development, Public Art, Air Quality Improvements and Nature Conservation Improvements being provided on site. On this basis, the development is considered compliant with policy and the associated guidance.

The decision to grant planning permission has been taken with regard to the policies and proposals in the adopted Black Country Core Strategy (BCCS) (2011), the Saved Dudley Unitary Development Plan (UDP) (2005) and to all other relevant material considerations.

The above is intended as a summary of the reasons for the grant of planning permission. For further detail on the decision please see the application report.

### Approval Statement

In dealing with this application the local planning authority have worked with the applicant in a positive and proactive manner, seeking solutions to problems arising in relation to dealing with the application, by seeking to help the applicant resolve technical detail issues where required and maintaining the delivery of sustainable development. The development would improve the economic, social and environmental concerns of the area and thereby being in accordance with paragraphs 186 and 187 of the National Planning Policy Framework (NPPF).

Conditions and/or reasons:

1. The development hereby permitted shall be begun before the expiration of three years from the date of this permission.
2. Notwithstanding the car parking details shown upon the approved plans and prior to the commencement of development, a plan shall be submitted and approved in writing by the Local Planning Authority showing 5 No. marked parking bays and 4 No. widened unmarked bays within the patients parking area. The parking layout shall be provided prior to the first occupation of the development and shall be retained throughout the life of the development
3. Prior to the commencement of development, details of the types, colours and textures of the materials to be used on the external surfaces of the buildings hereby approved shall be submitted to and approved in writing by the Local Planning Authority. The development shall be carried out in complete accordance with the approved details.

4. Landscape plans (including an establishment and maintenance programme), taking into account appropriate improvements for nature conservation shall be submitted and approved by the local planning authority before any development commences. All works must be carried out in accordance to the approved plans and programmes.
5. Prior to the commencement of development, details of the boundary treatments to be installed on the whole site shall be submitted to and approved in writing by the Local Planning Authority. The development shall proceed in accordance with the approved details, which shall be installed on site prior to occupation and thereafter maintained for the lifetime of the development unless otherwise agreed in writing by the Local Planning Authority.
6. No development shall commence until a Delivery Management and Parking Strategy has been submitted to and approved in writing by the local planning authority. The Strategy shall include details of the following:

- 1) the type and size of all vehicles ( other than staff and patient vehicles ), to ensure that there is sufficient space within the site to enter and exit in forward gear;
- 2) delivery times, to ensure that vehicles do not visit the site when the access gates are closed;
- 3) the route taken by vehicles to the site, to ensure that vehicles do not turn left into or out of the site.
- 4) details of the gate(s) operation system.
- 5) details of the banksman system and bollarding of spaces as required.

The development shall thereafter take place in accordance with the approved details, and shall take place in perpetuity in accordance with those details for the lifetime of the development.

7. No development shall commence until details for the provision of external electric charging points have been submitted to and approved in writing by the Local Planning Authority. The Electric Charging point(s) shall thereafter be provided in accordance with the approved details prior to first occupation of the development and be maintained for the life of the development.
8. The development hereby permitted shall not commence until drainage plans for the disposal of surface water and foul sewage have been submitted to and approved by the Local Planning Authority. The scheme shall be implemented in accordance with the approved details before the development is first brought into use and maintained throughout the life of the development.
9. Prior to the commencement of development, further site investigation works recommended within the Geo-environmental Assessment shall be undertaken. If the site investigations confirm the need for remedial works to treat any areas of shallow mine workings to ensure the safety and stability of the approved development, these measures shall be submitted to and approved in writing by the Local Planning Authority and prior to commencement of the development.
10. The noise rating level of any fixed plant and/or machinery associated with the development shall not exceed background noise levels at any nearby dwelling by more than 5dB(A), as assessed under the methodology of BS 4142 (1997) (Method for rating industrial noise affecting mixed residential and industrial areas) and/or its subsequent amendments.

11. No development shall commence until an Economic and Community Development Statement has been submitted to and approved in writing by the Local Planning Authority. The Statement shall address as a minimum, measures to increase the number of jobs open to local people available on the site and the development of initiatives that support activities to upskill local unemployed people of working age so as to support them into sustained employment as outlined in the Council's Planning Obligations Supplementary Planning Document. The development shall be implemented in accordance with the approved Statement and retained in accordance with the Statement for the lifetime of the development.
12. Prior to the first occupation of the building, the public art shall be implemented in accordance with the approved details (submitted under drawing No. A-DWG-2012-01-P (Revision R01) and Dated 29 October 2012. The works of public art shall thereafter be maintained for the life of the development.
13. Prior to the commencement of development, details of the existing and proposed levels of the site (including finished floor levels), which should be related to those of adjoining land and highways, shall be submitted to and approved in writing by the local planning authority. The development shall proceed in accordance with the approved levels.
14. No part of the development hereby permitted shall be commenced until full details of soft landscaping works have been submitted to and approved in writing by the Local Planning Authority. These details must include, where appropriate, planting plans, written specifications, a schedule of plants including species, plant sizes and proposed numbers/densities and a programme of implementation. Plans must also include accurate plotting of all existing landscape features.

The works approved as part of this condition shall be completed within the first planting season following first occupation.

Any trees or shrubs planted in pursuance of this permission including any planting in replacement for it which is removed, uprooted, severely damaged, destroyed or dies within a period of five years from the date of planting shall be replaced by trees or shrubs of the same size and species and in the same place unless otherwise agreed in writing by the Local Planning Authority.

15. No works should commence, or continue, if the most recent protected species survey and assessment is over 12 months old. These surveys and assessments must be of, or above, the standard detailed within the Nature Conservation SPD. They must include the whole of the site and be carried out by an experienced and qualified ecological consultant and integrated into a site mitigation plan. All of these must be submitted to and approved in writing by the Council before any works commence (or continue). All works must be carried out in accordance to the approved plan.
16. If protected species are found during any stage of the development all works must stop immediately and Natural England, the project's ecologist and the Council's Nature Conservation Officer must be contacted immediately. Works should not re-commence until relevant licences have been obtained and written permission is granted by Natural England and the Council.



17. The demolition of the buildings and the clearance of trees and other vegetation should avoid the bird nesting season (February – August inclusive) unless a breeding bird assessment (with recommendations) is carried out by a trained ecologist within 7 days of the works commencing. This should be submitted in writing and approved by the Council before works begin. All works must be carried out in accordance to the approved assessment's recommendations.
18. A plan detailing suitable replacement native trees, and their establishment programme, should be submitted and approved in writing by the Council before any works proceed. All works must be carried out in accordance to the approved plan and programme.
19. Any outside lighting should conform to the Bat Conservation Trust and Institute for Lighting Engineers' guidance 'Bats and lighting in the UK'. It should be close to the ground and directed downwards. It should be activated by a timed sensor with a low movement sensitivity, so as not to be triggered by wildlife. A plan detailing outside lighting will be submitted and approved in writing by the Council before any works proceed. All works must be carried out in accordance to the approved plan.
20. No development shall commence until details of secure cycle parking facilities in accordance with the Council's parking standards have been submitted to and approved in writing by the Local Planning Authority. The cycle parking shall thereafter be provided in accordance with the approved details prior to first occupation of the development, shall be made available at all times and be maintained for the life of the development.
21. The development shall not be occupied until a Travel Plan has been submitted to and approved in writing by the local planning authority, including details of a Travel Plan Co-ordinator, Staff Travel Survey, Car Parking Management, Walking and Cycling initiatives, Publicity and Marketing, Set targets and monitoring and to join Company Travel Wise in Dudley together with a timetable for the implementation of each such element. The Travel Plan shall be implemented in accordance with the details approved by the local planning authority and remain operational for the life of the development.
22. No development shall commence until details of the highway works have been submitted to and approved in writing by the local planning authority. The development shall not be occupied until these highway works have been implemented in accordance with the approved details. The highway works shall include a new widened footway in clinic drive, new footways in Jackson Street to an adoptable highway standard. The existing footways in Jackson Street shall also be improved to a carriageway construction specification to be able to withstand loads from large articulated vehicles.
23. The development hereby permitted shall be carried out in accordance with the following approved plans:  
'A-DWG-010-004-P (Revision R05) Dated 08 March 2012', 'A-DWG-101-00-P (Revision R03) Dated 08 March 2012', 'A-DWG-101-02-P (Revision R03) Dated 08 March 2012', 'A-DWG-200-02-P (Revision R07) Dated 08 March 2012', 'A-DWG-210-01-P (Revision R01) Dated 29 October 2012', 'A-DWG-060-01-P (Revision R04) Dated 08 March 2012', 'A-DWG-101-01-P (Revision R06) Dated 08 March 2012', 'A-DWG-101-04-P (Revision R03) Dated 08 March 2012', 'A-DWG-200-04-P (Revision R06) Dated 08 March 2012', 'A-DWG-200-03-P (Revision R07) Dated 08 March 2012', 'A-DWG-301-00-P (Revision R02) Dated

08 March 2012' 'A-DWG-200-05-P (Revision R05) Dated 08 March 2012', 'A-DWG-302-00-P (Revision R03) Dated 08 March 2012', 'A-DWG-015-01-P (Revision R02) Dated 08 March 2012', 'A-DWG-050-02-P (Revision R03) Dated 08 March 2012', 'A-DWG-050-01-P (Revision R03) Dated 08 March 2012', 'A-DWG-011-00-P (Revision R02) Dated 30 March 2012', ' A-DWG-020-00-P (Revision R05) Dated 08 March 2012' and A-DWG-010-001-P (Revision R05) Dated 08 March 2012'.

Rev.	Date	Description	By
R01	30.03.12	Planning Issue	SG
R02	30.03.12	Planning Issue	SG
R03	30.03.12	Planning Issue	SG
R04	02.04.12	Planning Issue	SG
R05	02.04.12	Planning Issue	SG

**Notes**

Site level information obtained from Interlock Surveys Ltd Drawing dated 20/08/10

 Site area of development to be acquired by LIFT Co.

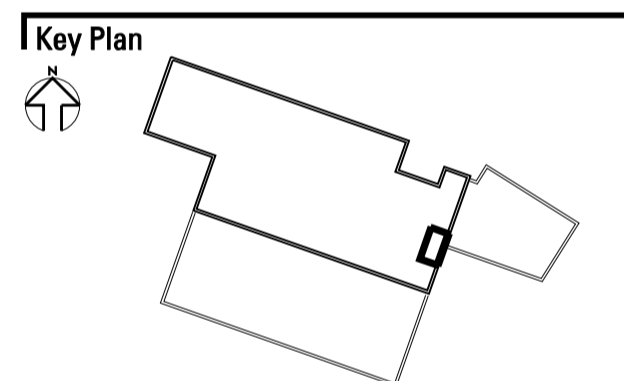

DO NOT SCALE FROM DRAWING ALL DIMENSIONS TO BE CHECKED ON SITE

FOR PLANNING APPROVAL

**ARCHITECTS**  
**sh**  
STEFFIAN BROADLEY

200 St John Street  
London  
EC1V 4RN  
T (020) 7549 4050  
F (020) 7549 4051  
www.steffian.com

Project Number <b>8202.000</b>	Scale <b>1:500</b>	A1
-----------------------------------	-----------------------	----

Client  
**Dudley Infracare LIFT  
Ashley House PLC**

Project  
**Lye Health Centre**

Title  
**Location Plan**

Drawing No <b>A-DWG-010-001-P</b>	Revisions <b>R05</b>
--------------------------------------	-------------------------

Date	Drawn	Checked	Approved
03/03/12	KJ	SG	RC
Plotted: datedateddatedated By: usernameuser			

Rev.	Date	Description	By
R01	30.03.12	Planning Issue	SG
R02	30.03.12	Planning Issue	SG
R03	29.10.12	Planning Issue	ST

Notes

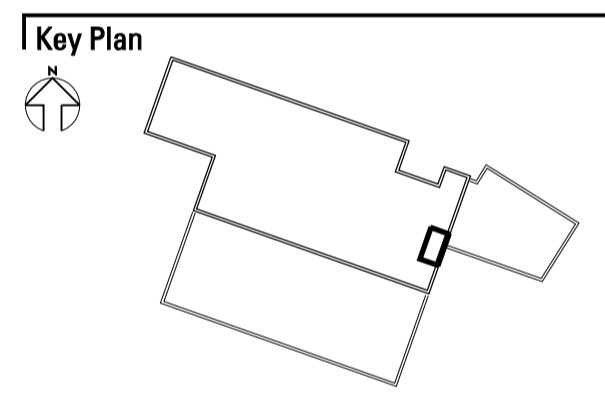
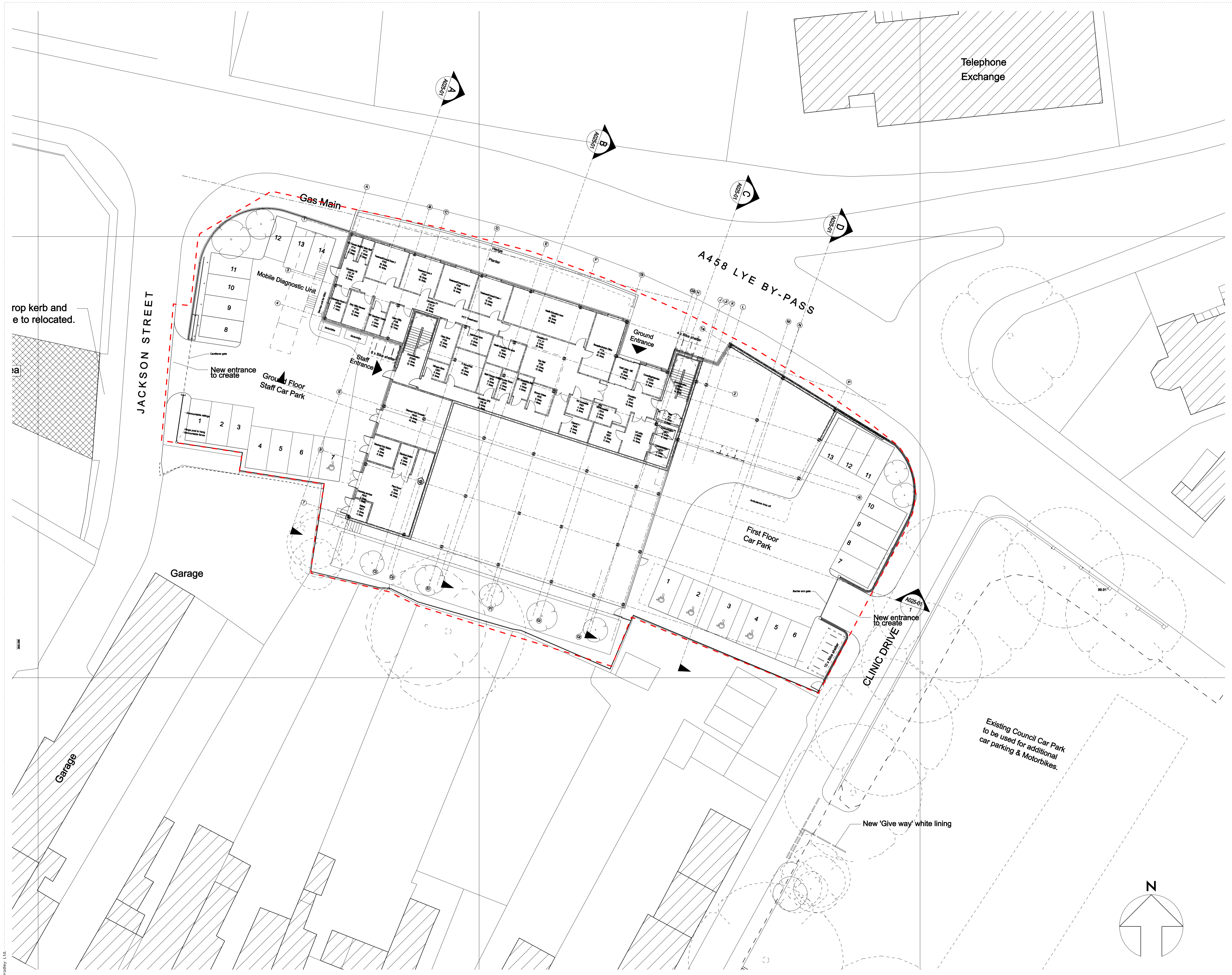

DO NOT SCALE FROM DRAWING ALL DIMENSIONS TO BE CHECKED ON SITE  
FOR PLANNING APPROVAL

**ARCHITECTS**  
**sh**  
200 St John Street  
London  
EC1V 4RN  
T (020) 7549 4050  
F (020) 7549 4051  
www.steffian.com

Project Number 8202.000 Scale 1:200 @ A1

Client  
**Dudley Infracare LIFT  
Ashley House PLC**

Project  
**Lye Health Centre**

Title  
**General Arrangement  
Lower Ground Floor**

Drawing No **A-DWG-101-00-P** Revisions **R03**

Date	Drawn	Checked	Approved
03/03/12	SG	DH	RC
File: d:\dwg\101-00-p.dwg Plotted: 29/10/12 14:54:54 By: user\nameuser			

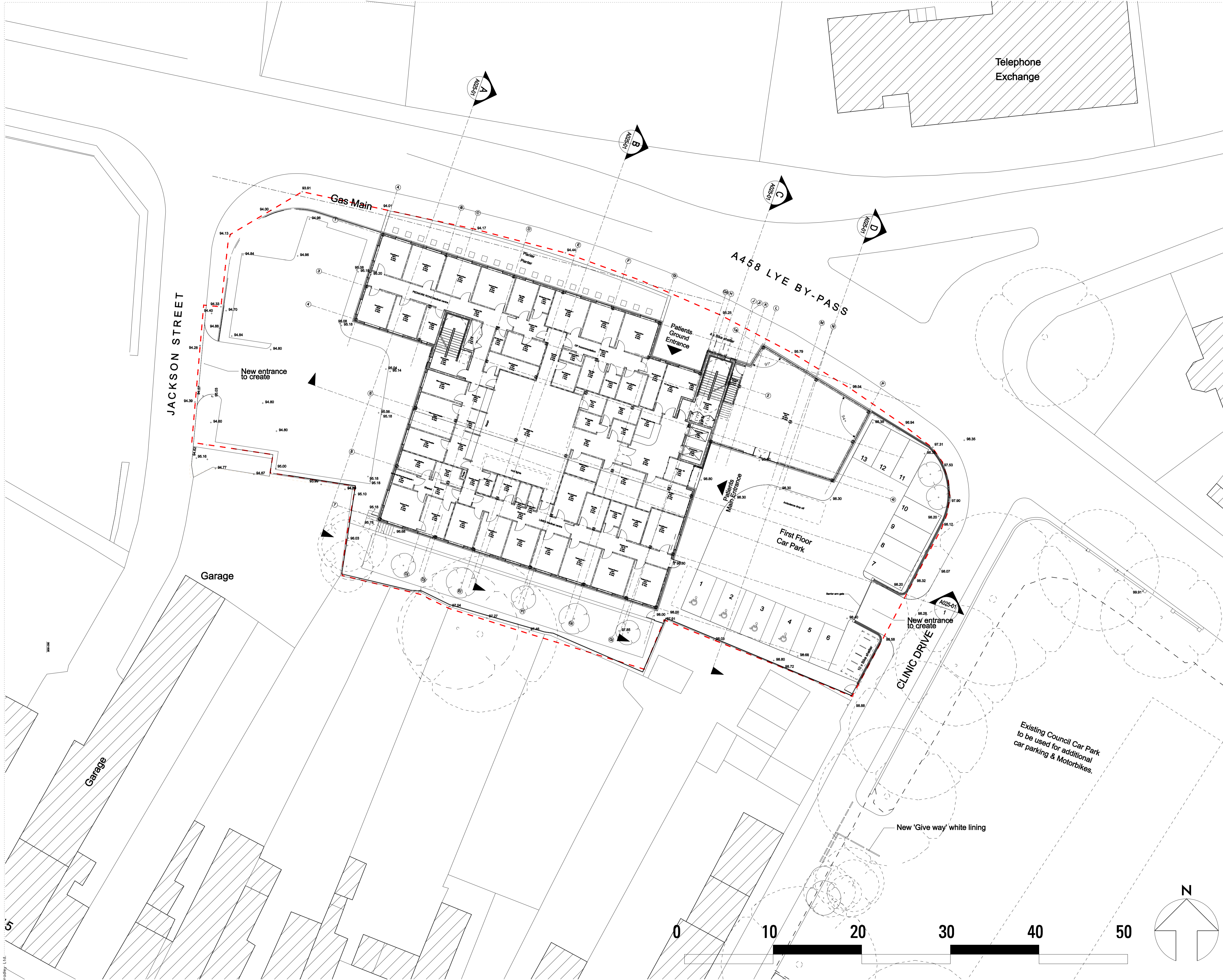

Rev.	Date	Description	By
R01	30.03.12	Planning Issue	SG
R02	30.03.12	Planning Issue	SG
R03	30.03.12	Planning Issue	SG
R04	30.03.12	Planning Issue	SG
R05	16.04.12	Planning Issue	SG
R06	22.10.12	Planning Issue	ST

Notes

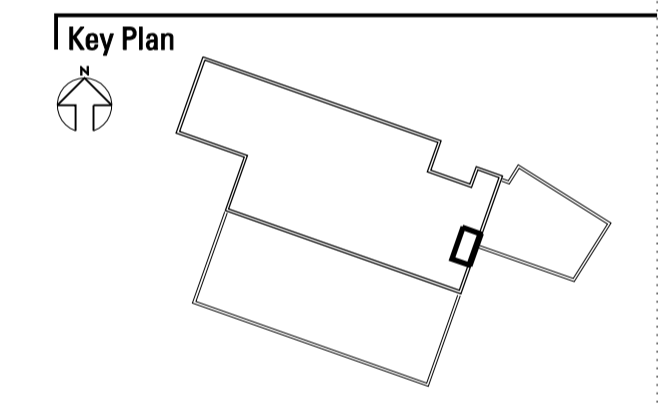

DO NOT SCALE FROM DRAWING ALL DIMENSIONS TO BE CHECKED ON SITE  
FOR PLANNING APPROVAL

**ARCHITECTS** **sh**  
200 St John Street  
London  
EC1V 4RN  
T (020) 7549 4050  
F (020) 7549 4051  
www.steffian.com

Project Number 8202.000 Scale 1:200 @ A1

Client  
**Dudley Infracare LIFT  
Ashley House PLC**

Project  
**Lye Health Centre**

Title  
**General Arrangement  
Upper Ground**

Drawing No **A-DWG-101-01-P** Revisions **R06**

Date	Drawn	Checked	Approved
03/03/12	SG	DH	RC

File: d:\dwg\101-01-01.dwg  
Plotted: 22/10/2012 14:56:25  
By: userameuser



Staff Entrance Elevation  
(West)



Lye by-pass Elevation  
(North)

Rev.	Date	Description	By
R01	30.03.12	Planning Issue	SG
R02	30.03.12	Planning Issue	SG
R03	30.03.12	Planning Issue	SG
R04	02.04.12	Planning Issue	SG
R05	29.10.12	Planning Issue	ST
R06	31.10.12	Planning Issue	ST

Notes  
ILLUSTRATIVE PURPOSES NOT TO SCALE

- Indicative artwork proposal.
- For further information refer to drawing: A-DWG-210-01-P
- For images of railings around the car parks refer to drawing: A-DWG-060-01-P

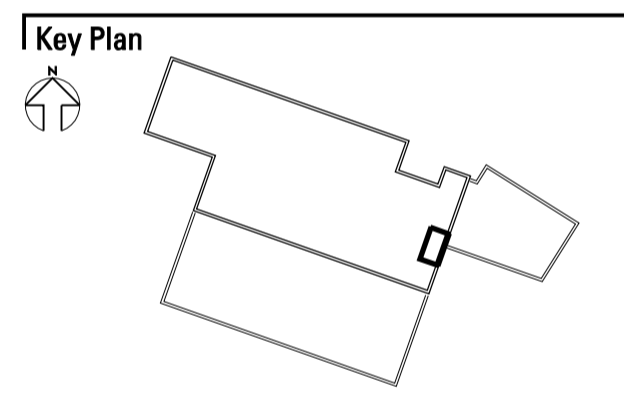

DO NOT SCALE FROM DRAWING ALL DIMENSIONS TO BE CHECKED ON SITE

FOR PLANNING APPROVAL

**ARCHITECTS**  
**sh**  
200 St John Street  
London  
EC1V 4RN  
T (020) 7549 4050  
F (020) 7549 4051  
www.steffian.com

Project Number 8202.000 Scale NA A1

Client  
Dudley Infracare LIFT  
Ashley House PLC

Project  
Lye Health Centre

Title  
North & West  
Colour Elevation

Drawing No A-DWG-200-04-P Revisions R06

Date	Drawn	Checked	Approved
03/03/12	SG	DH	RC

Plotted: datedatedatedated  
By: usernameuser



Patient and Vehicle flow diagram

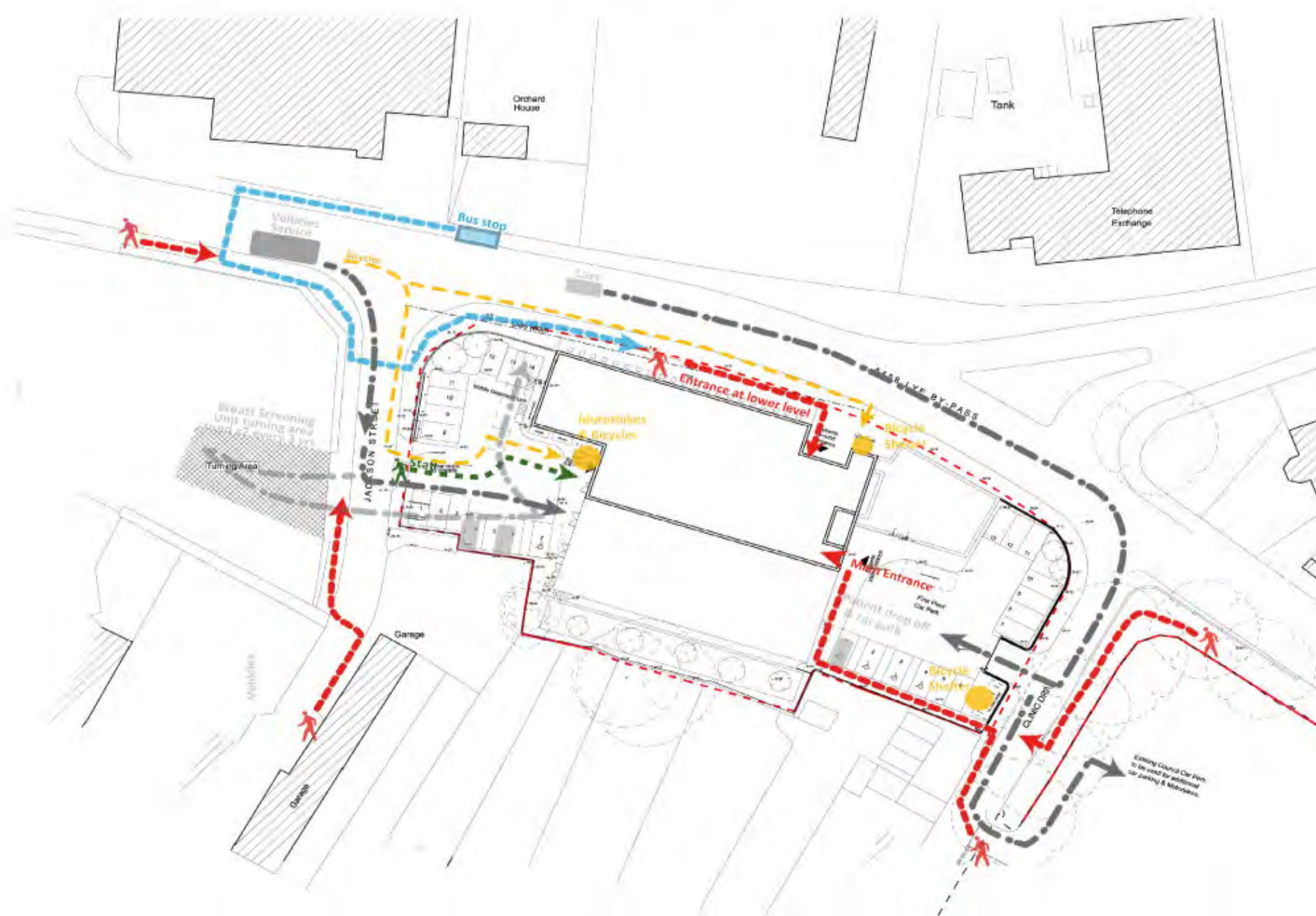

Aerial view from Lye by-pass

Rev.	Date	Description	By
R01	30.03.12	Planning Issue	SG
R02	30.03.12	Planning Issue	SG
R03	02.04.12	Planning Issue	SG

Notes

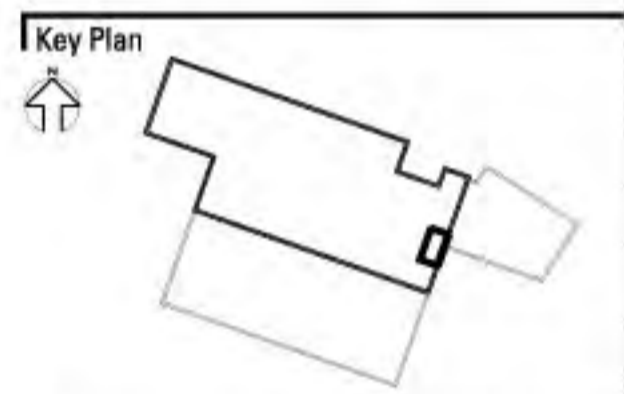

DO NOT SCALE FROM DRAWING ALL DIMENSIONS TO BE CHECKED ON SITE

FOR PLANNING APPROVAL

**ARCHITECTS** **sha** STEFFIAN ARCHITECTS

200 St John Street  
London  
EC1V 4RN  
T (020) 7549 4050  
F (020) 7549 4051  
www.steffian.com

Project Number 8202.000 Scale A1

Client  
**Dudley Infracare LIFT  
Ashley House PLC**

Project  
**Lye Health Centre**

Title  
**Site Pedestrian &  
Vehicle Flow**

Drawing No **A-DWG-050-02-P** Revisions **R03**

Date	Drawn	Checked	Approved
02/04/12	KJ	SS	RC
Plotted:	dated	dated	dated
By:	username		



Main Entrance Elevation  
(East)



East Elevation  
(South)

Rev.	Date	Description	By
R01	30.03.12	Planning Issue	SG
R02	30.03.12	Planning Issue	SG
R03	30.03.12	Planning Issue	SG
R04	02.04.12	Planning Issue	SG
R05	29.10.12	Planning Issue	ST

Notes

FOR ILLUSTRATIVE PURPOSES ONLY  
NOT TO SCALE  
REFER TO DRAWING:  
A-DWG-060-01-P  
FOR RAILINGS AROUND  
CAR PARK

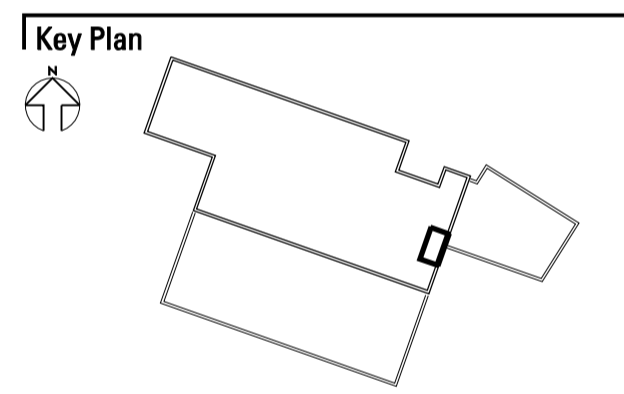

DO NOT SCALE FROM DRAWING ALL  
DIMENSIONS TO BE CHECKED ON SITE

FOR PLANNING APPROVAL

**ARCHITECTS** **sha** STEFFIAN ARCHITECTS

200 St John Street  
London  
EC1V 4RN  
T (020) 7549 4050  
F (020) 7549 4051  
www.steffian.com

Project Number	Scale
8202.000	NA A1

Client  
**Dudley Infracare LIFT  
Ashley House PLC**

Project  
**Lye Health Centre**

Title  
**South & East  
Colour Elevations**

Drawing No	Revisions
<b>A-DWG-200-05-P</b>	<b>R05</b>

Date	Drawn	Checked	Approved
03/03/12	SG	DH	RC
Plotted: datedatedatedated By: usernameuser			



Rev.	Date	Description	By
R01	20.03.12	Planning Issue	SG
R02	20.03.12	Planning Issue	SG
R03	20.03.12	Planning Issue	SG
R04	02.04.12	Planning Issue	SG
R05	16.04.12	Planning Issue	SG
R06	22.10.12	Planning Issue	ST
R07	31.10.12	Planning Issue	ST

Notes  
Material Key

- Note: Please read in conjunction with colour elevations and illustrations on drawings:  
A\_200\_04 + 200\_5 + 060\_01
1. Brickwork with recessed detailing.
  2. Green acrylic high performance render with reveal joints shown.
  3. White acrylic high performance render with reveal joints shown.
  4. 'Copper' look alkali rain screen cladding system. With possible break out panels  
Colour: LuraDecor - Patina Copper V
  5. Grey window frames and door frame unit
  6. Galvanised steel handrail
  7. Pressed aluminium paneling/ lower panels. Light grey colour.
  8. Metal railings
  9. Low level brick planters
  10. Photo voltaics
  11. Square section drain pipe with hopper.
  12. Overflow
  13. Cat ladder

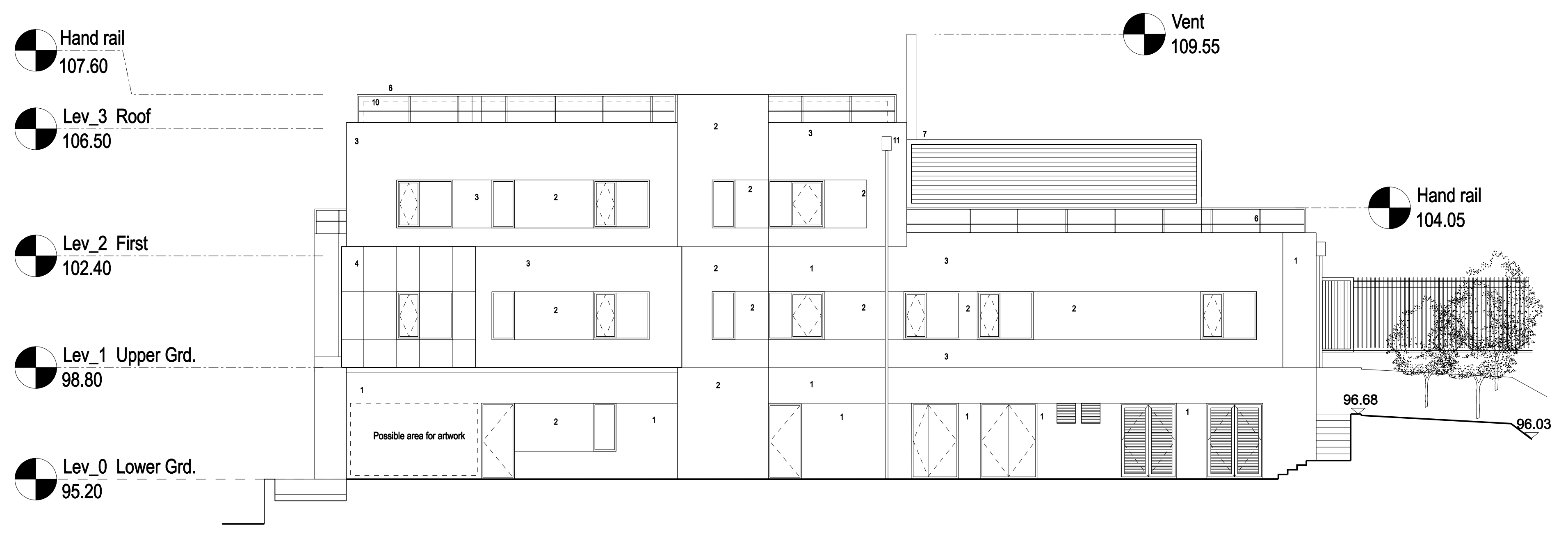

Staff Entrance Elevation  
(C) West

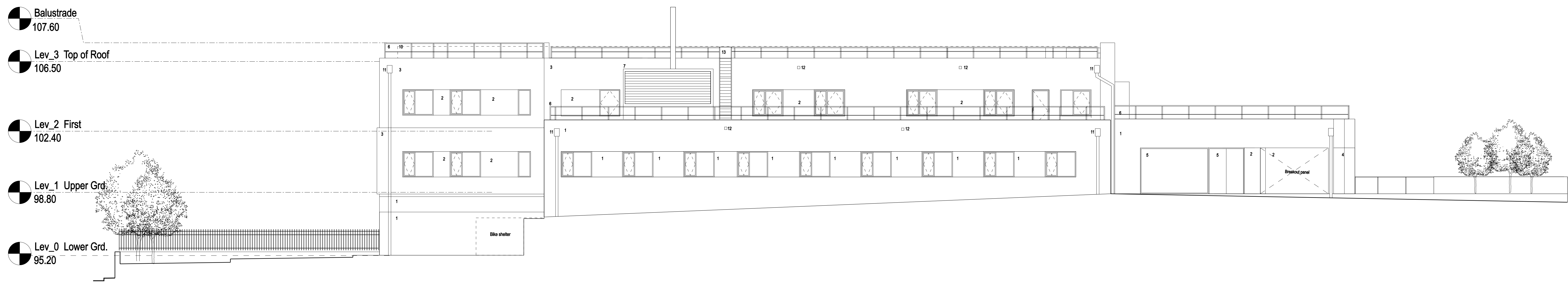

Rear Elevation  
(D) South

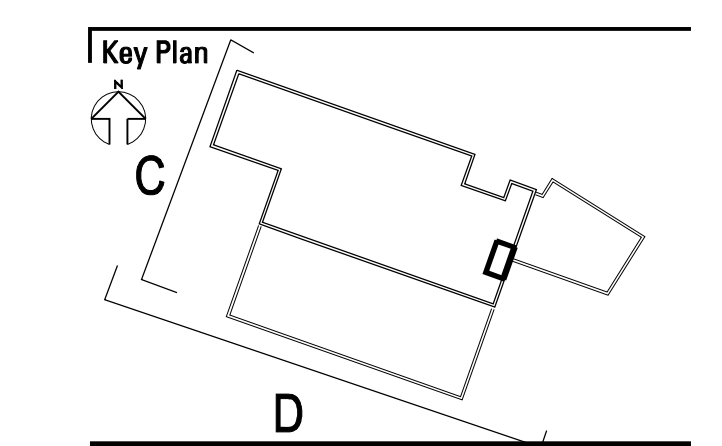

DO NOT SCALE FROM DRAWING ALL DIMENSIONS TO BE CHECKED ON SITE  
FOR PLANNING APPROVAL

**ARCHITECTS**  
**sha**  
200 St John Street  
London  
EC1V 4RN  
T: (020) 7549 4090  
F: (020) 7549 4061  
www.steffian.com

Project Number: 8202.000 | Scale: 1:100 @ A0

Client:  
**Dudley Infracare LIFT  
Ashley House PLC**

Project:  
**Lye Health Centre**

Title:  
**West & South  
Lye Elevations**

Drawing No: **A-DWG-200-03-P** | Revisions: **R07**

Date	Drawn	Checked	Approved
08.03.12	SG	DN	SG

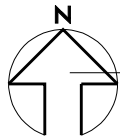

No.	Date	Description	By
01	24.01.12	Final Issue	SB
02	02.04.12	Final Issue	SB

Notes

Site level information obtained from Interlock Surveys Ltd Drawing dated 20/08/10

Site area of development to be acquired by LIFT Co.

Key Plan



DO NOT SCALE FROM DRAWING ALL DIMENSIONS TO BE CHECKED ON SITE

**ARCHITECTS** **sha** 200 St John Street  
London  
EC1V 4RN  
T (020) 7649 4060  
F (020) 7649 4061  
www.steffian.com

Project Number: 8203.000 Scale: 1:1250 @ A4

Client: Dudley Infracare LIFT Ashley House PLC

Project: Lye Health Centre

Title: Existing Site Plan

Drawing No: A-DWG-011-00-P Revisions: R02

Date	Drawn	Checked	Approved
24.01.12	SB	SB	KJ



View looking from the Lye By-pass



River Stour and Green Spaces Map

Rev.	Date	Description	By
R01	28.10.12	Planning Issue	ST

Notes

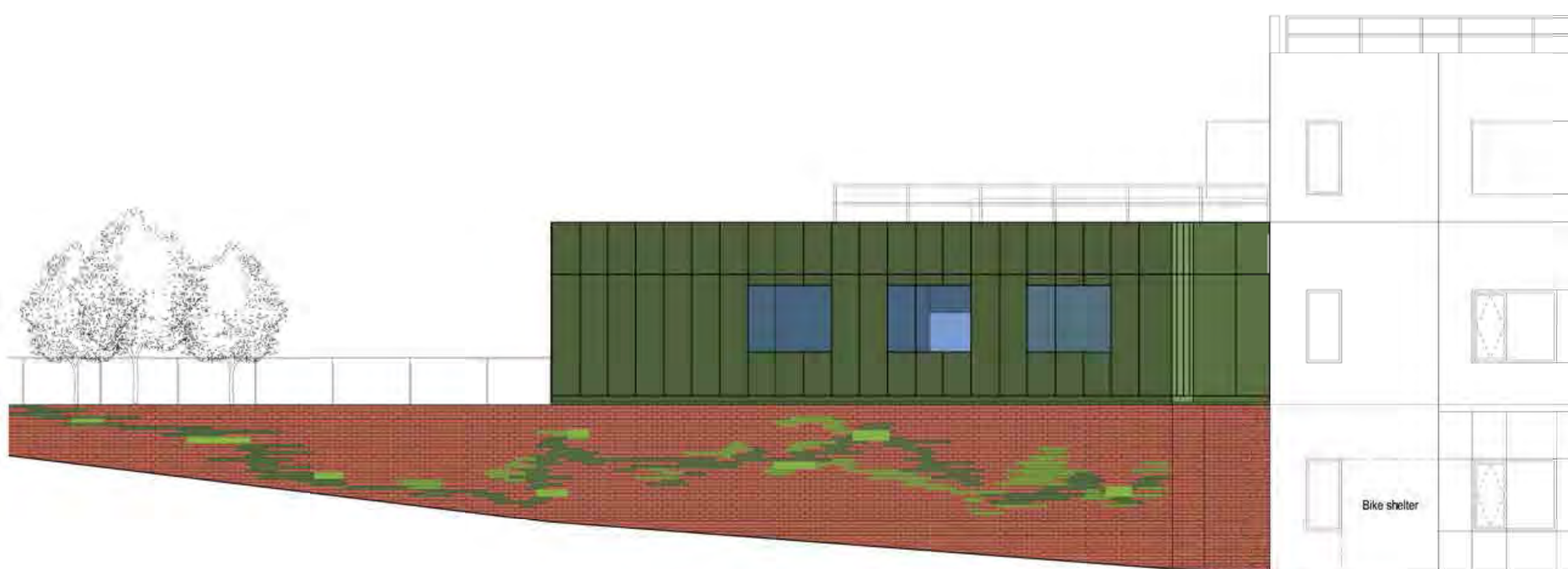
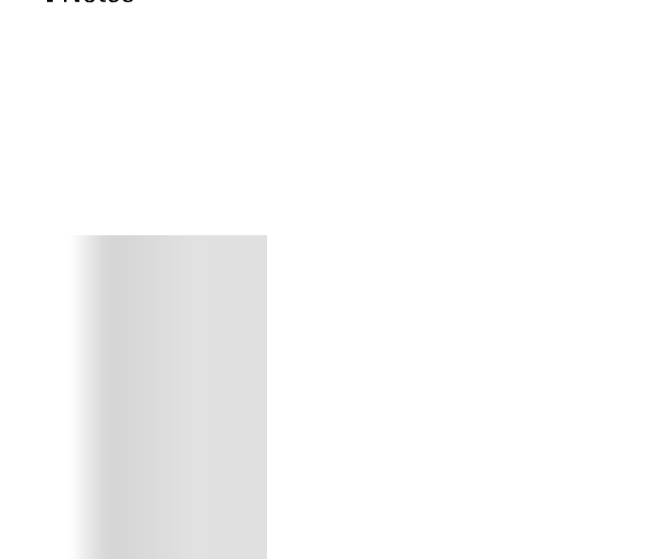

The Art Wall - Elevation

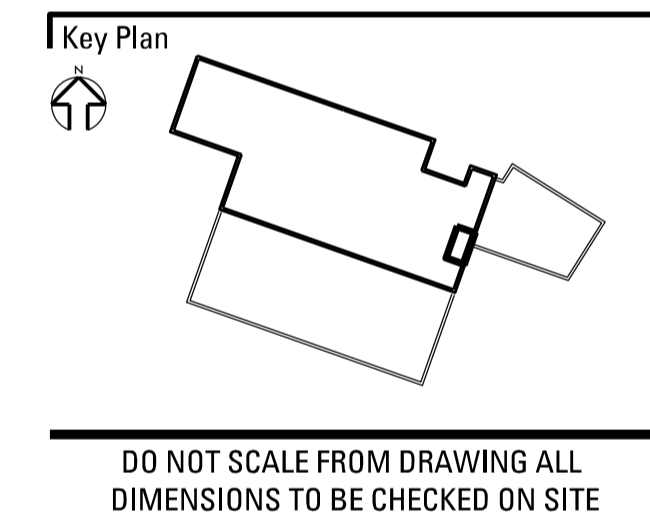

FOR PLANNING APPROVAL

**ARCHITECTS**  
*shar*  
STEFFIAN BRADY

200 St John Street  
London  
EC1V 4RN  
T (020) 7549 4050  
F (020) 7549 4051  
www.steffian.com

Project Number	8202.000	Scale	NA A1
----------------	----------	-------	-------

Client  
**Dudley Infracare LIFT  
Ashley House PLC**

Project  
**Lye Health Centre**

Title  
**An Indicative  
Artwork Proposal**

Drawing No	A-DWG-210-01-P	Revisions	R01
------------	----------------	-----------	-----

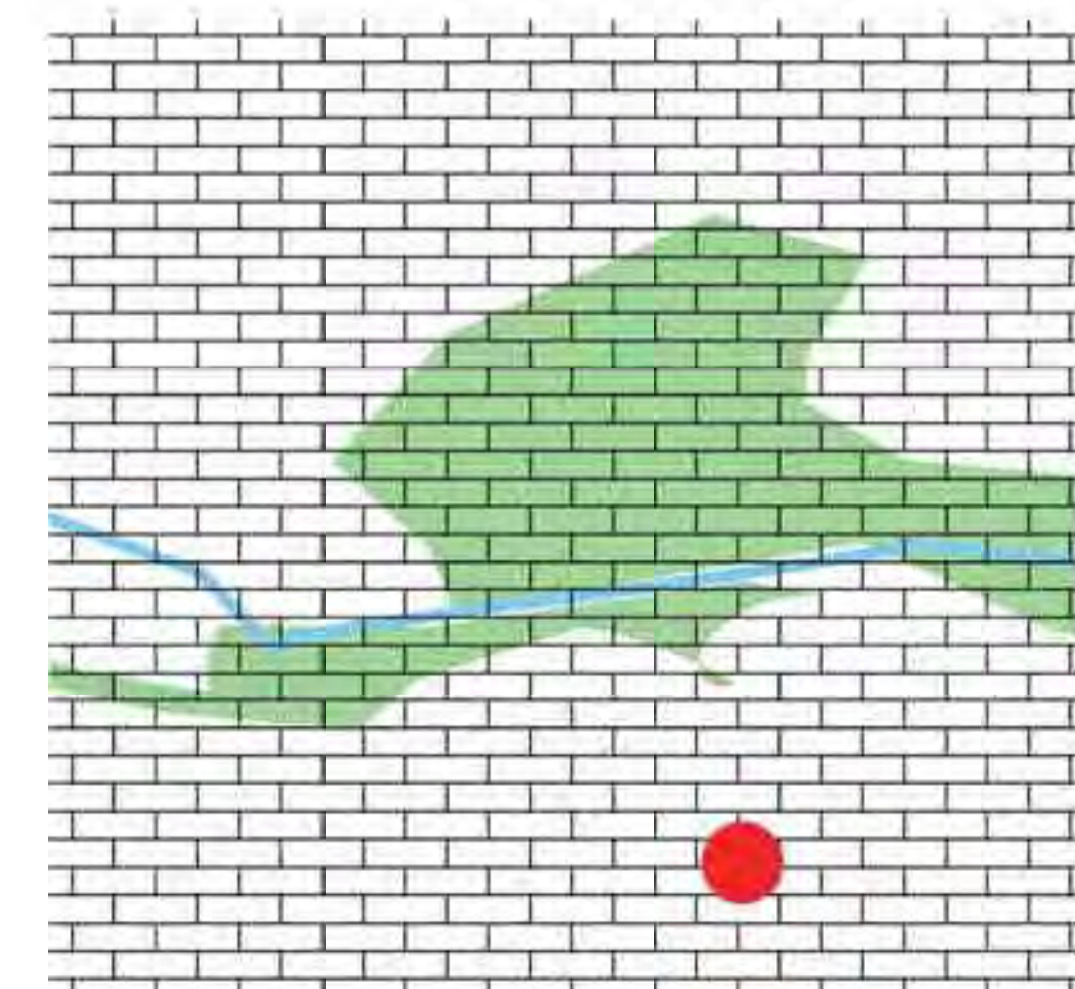

1 Section of the river and parks superimposed onto the brick

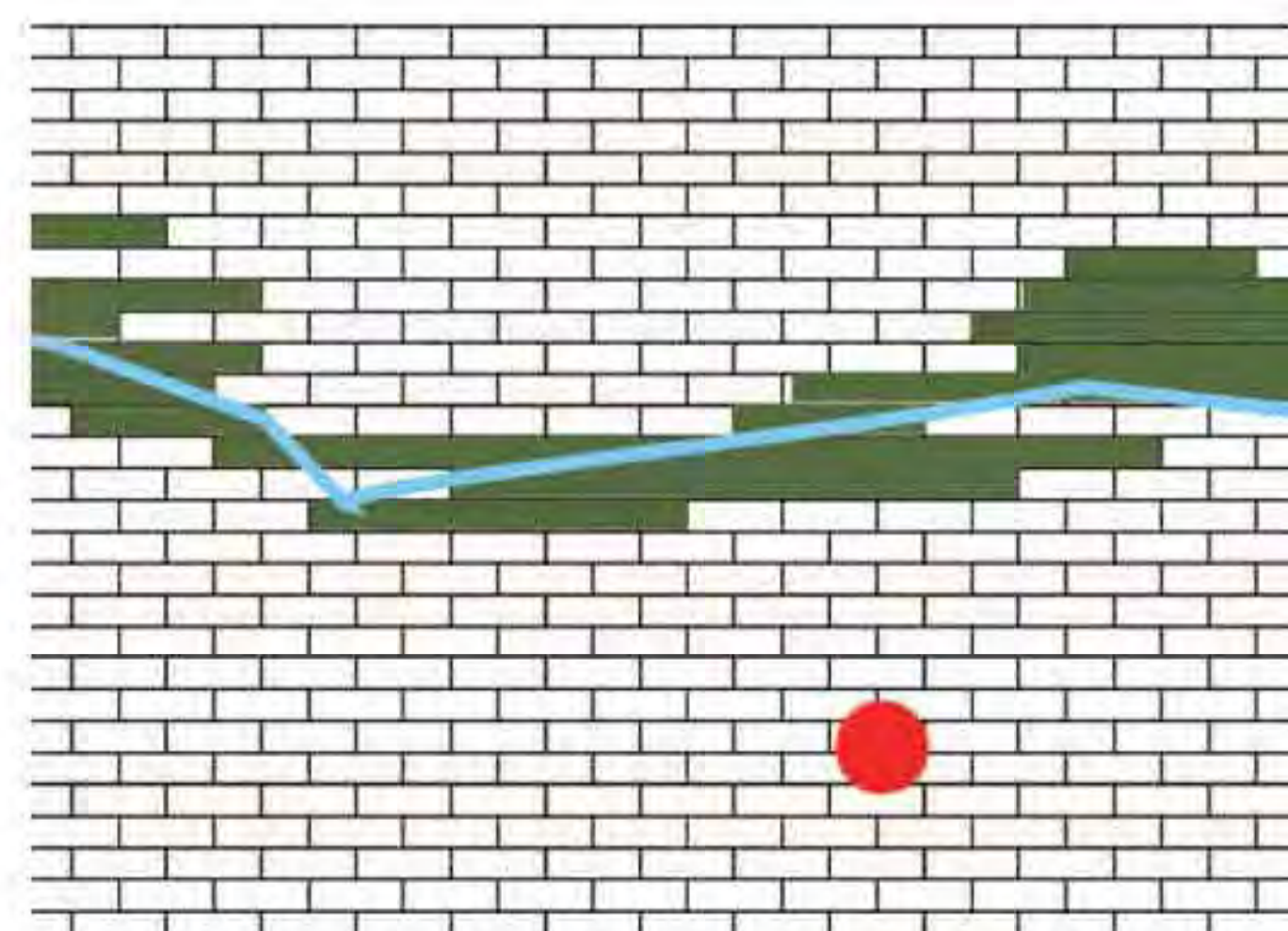

2 Linear bands of glazed, recessed, bricks arranged to reflect the river route

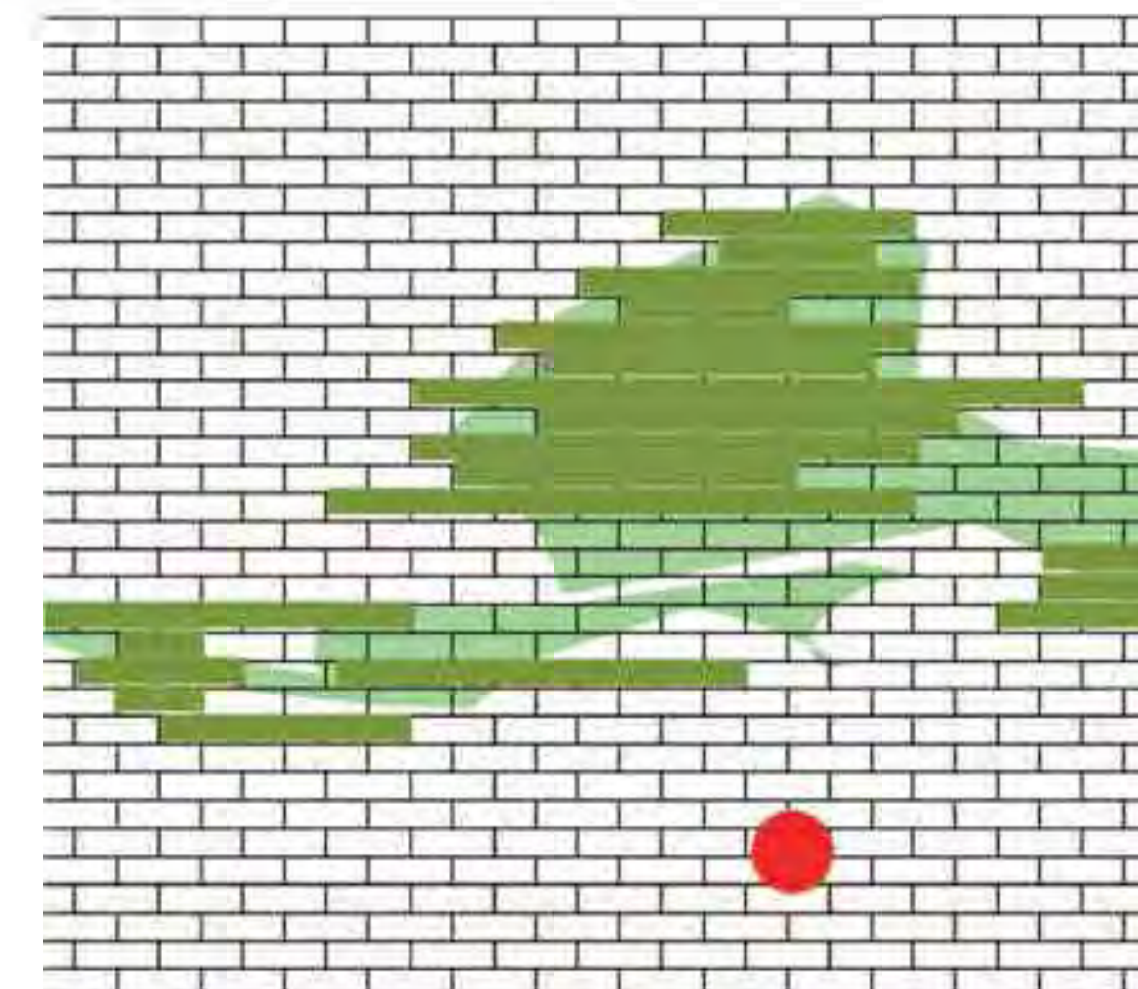

3 A similar colour to the render would be selected to reflect the parks

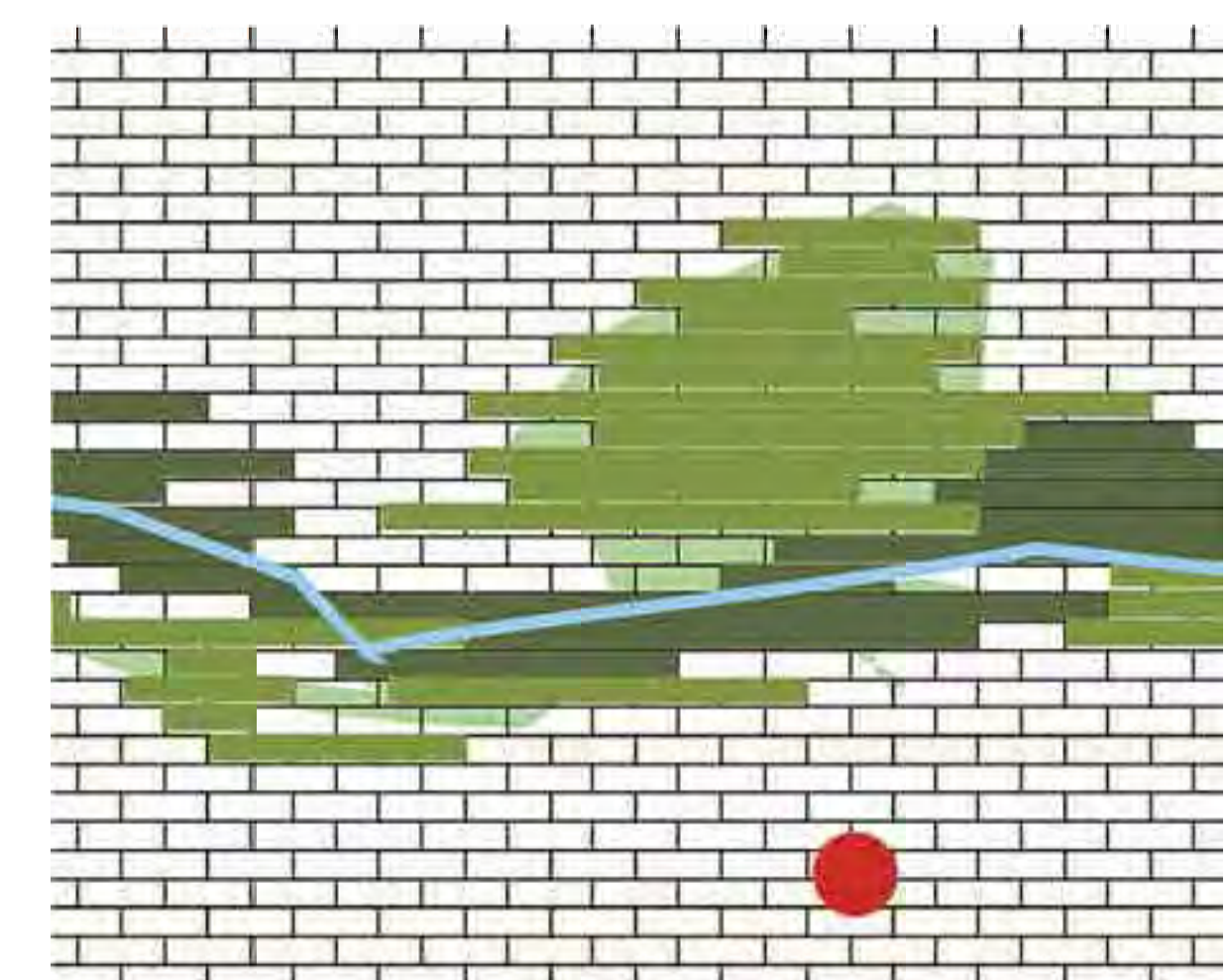

4 The glazed bricks would come together to represent River Stour and the parks

Date	28.10.12	Drawn	ST	Checked	DH	Approved	RC
------	----------	-------	----	---------	----	----------	----

Plotted: datedatedated  
By: usernameuser

Rev.	Date	Description	By
R01	20.03.12	Planning Issue	SS
R02	20.03.12	Planning Issue	SS
R03	20.03.12	Planning Issue	SS
R04	02.04.12	Planning Issue	SS
R05	22.10.12	Planning Issue	ST
R06	26.10.12	Planning Issue	ST
R07	31.10.12	Planning Issue	ST

Notes

Material Key

Note: Please read in conjunction with colour elevations and illustrations on drawings:  
 A\_200\_04 + 200\_5 + 60\_01  
 1. Brickwork with recessed detailing.  
 Colour: Red/ orange/brown  
 2. Green acrylic high performance render with reveal joints shown.  
 3. White acrylic high performance render with reveal joints shown.  
 4. Copper look alloy main screen cladding system. With possible break out panels  
 Colour: EuroDecor - Patina Copper V  
 5. Grey window frames and door frame unit  
 6. Galvanised steel handrail  
 7. Pressed aluminium paneling/ lower panels.  
 Light grey colour.  
 to conceal plant beyond  
 8. Metal railings  
 9. Low level brick planters  
 10. Photo voltaics  
 11. Square section drain pipe with hopper.  
 Colour: grey to match window and door frames.  
 12. Overflow

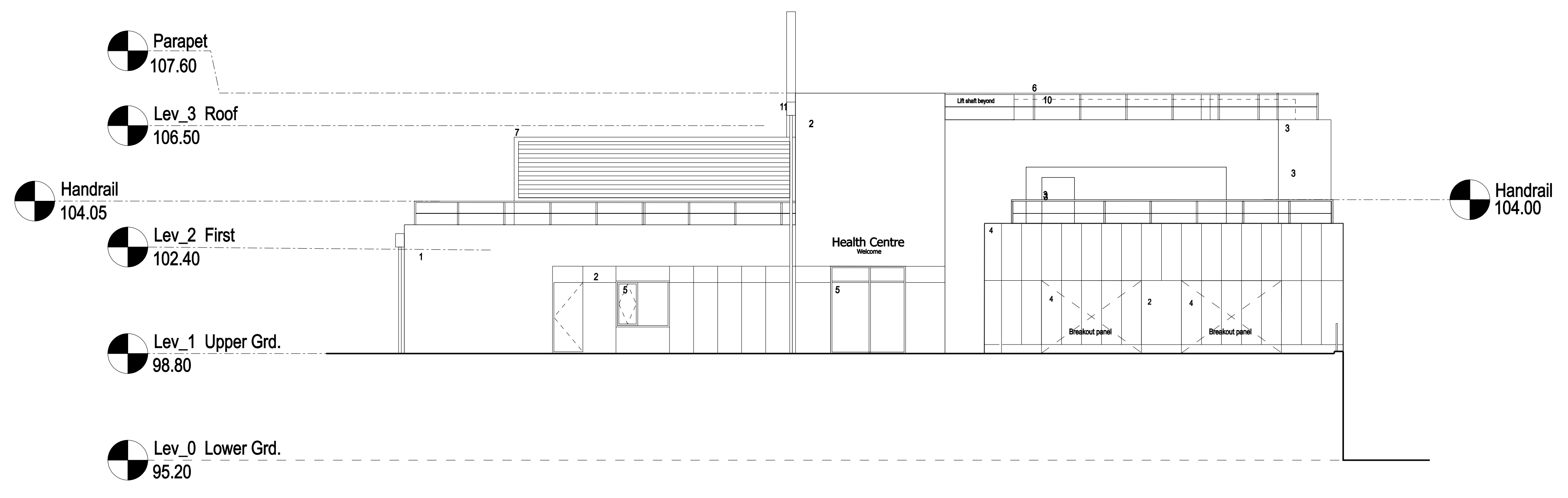

Main Entrance Elevation (A) East

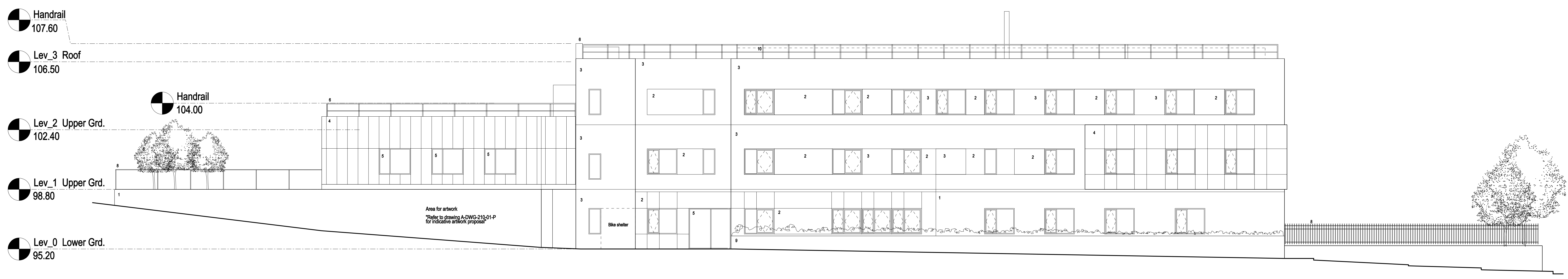

Lye by-pass Elevation (B) North

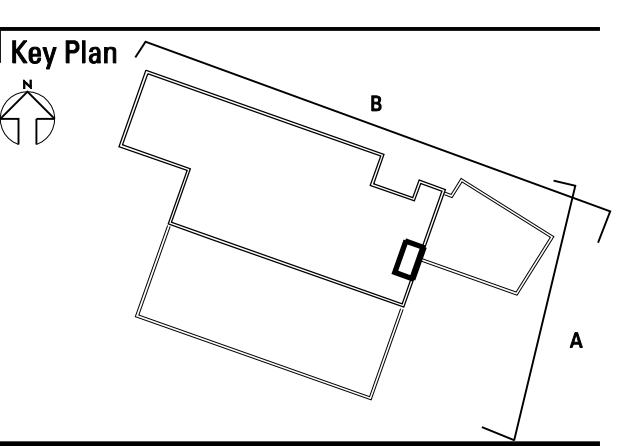

DO NOT SCALE FROM DRAWING ALL DIMENSIONS TO BE CHECKED ON SITE  
 FOR PLANNING APPROVAL

ARCHITECTS  
**sha**  
 200 St John Street  
 London  
 EC1V 4RN  
 T: (020) 7549 4060  
 F: (020) 7549 4061  
 www.steffian.com

Project Number 8202.000 Scale 1:100 @ A0

Client  
**Dudley Infracare LIFT  
 Ashley House PLC**

Project  
**Lye Health Centre**

Title  
**North & East  
 Lye Elevations**

Drawing No  
**A-DWG- 200-02-P** Revisions  
**R07**

Date	Drawn	Checked	Approved
08.12	SS	SS	SS



Rev.	Date	Description	By
R01	30.03.12	Planning Issue	SG
R02	30.03.12	Planning Issue	SG
R03	02.04.12	Planning Issue	SG
R04	05.10.12	Planning Issue	SG
R05	01.11.12	Planning Issue	ST

**Notes**

- Total Site Area 2,989m<sup>2</sup> (0.298 ha)
- HARD LANDSCAPING
- INTENSIVE WILD FLOWERS / MEADOW PLANTING
- SOFT LANDSCAPING LOW MAINTAINANCE PLANTING
- HEDGING
- POSSIBLE TREE TYPE: PYRUS CALLERYANA 'CHANTICLEER'.

Bicycle store: 20  
 Motorbike stores: 2  
 Ownership boundary defined by Land Registry  
 Official copy of the plan.  
 Title number WM924820  
 Email dated 11th October 2010



HEDGING EXAMPLES



WILDFLOWERS AND GRASSES

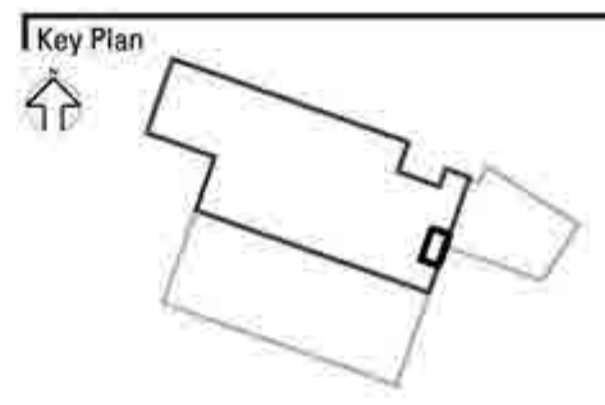

DO NOT SCALE FROM DRAWING ALL DIMENSIONS TO BE CHECKED ON SITE

FOR PLANNING APPROVAL

**ARCHITECTS** **sh**  
 200 St John Street  
 London  
 EC1V 4RN  
 T (020) 7549 4050  
 F (020) 7549 4051  
 www.steffian.com

Project Number	Scale	A1
8202.000	1:200	

Client  
**Dudley Infracare LIFT  
 Ashley House PLC**

Project  
**Lye Health Centre**

Title  
**Hard & Soft  
 Landscaping**

Drawing No	Revisions
<b>A-DWG-010-004-P</b>	<b>R05</b>

Date	Drawn	Checked	Approved
05.03.12	KJ	CS	RC

Plotted: datedatedatedated  
 By: usernameuser

Rev.	Date	Description	By
R01	30.03.12	Planning Issue	SG
R02	30.03.12	Planning Issue	SG
R03	22.10.12	Planning Issue	ST

Notes

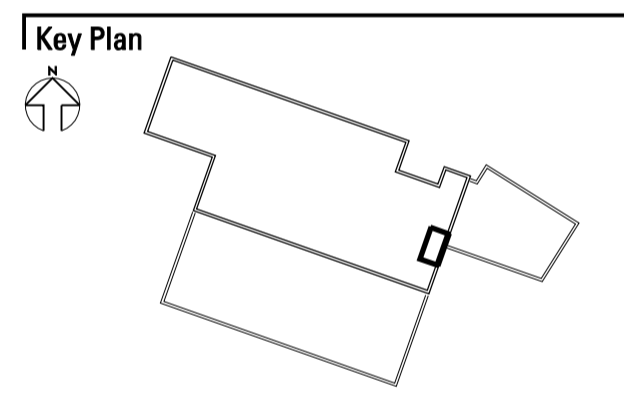
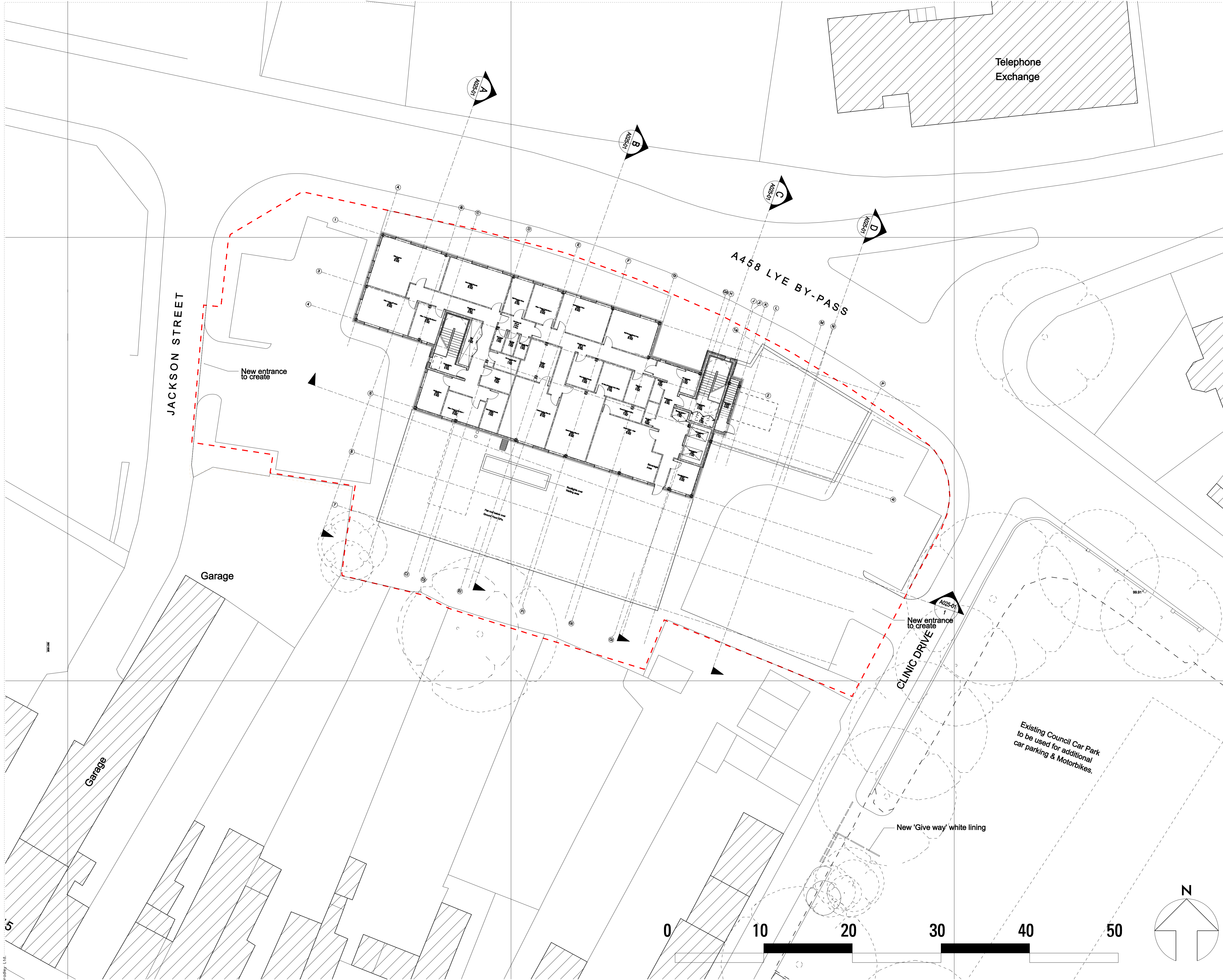

DO NOT SCALE FROM DRAWING ALL DIMENSIONS TO BE CHECKED ON SITE FOR PLANNING APPROVAL

**ARCHITECTS**  
shd  
200 St John Street  
London  
EC1V 4RN  
T (020) 7549 4050  
F (020) 7549 4051  
www.steffian.com

Project Number 8202.000 Scale 1:200 @A1

Client  
**Dudley Infracare LIFT  
Ashley House PLC**

Project  
**Lye Health Centre**

Title  
**General Arrangement  
First Floor**

Drawing No **A-DWG-101-02-P** Revisions **R03**

Date	Drawn	Checked	Approved
03/03/12	SG	DH	RC

Plotted: datedateddatedated  
By: usernameuser

Rev.	Date	Description	By
R01	30.03.12	Planning Issue	SG
R02	30.03.12	Planning Issue	SG
R03	02.24.12	Planning Issue	SG

**Notes**  
 Read in conjunction with drawing series A-DWG-010, A-DWG-015 & A-DWG-010-002  
 Site level information obtained from Interlock Surveys Ltd drawing dated 30/8/10  
 Read in conjunction with Regeneration Plan for Lye, Eco Appraisal and Bot Survey Document Tree Assessment document

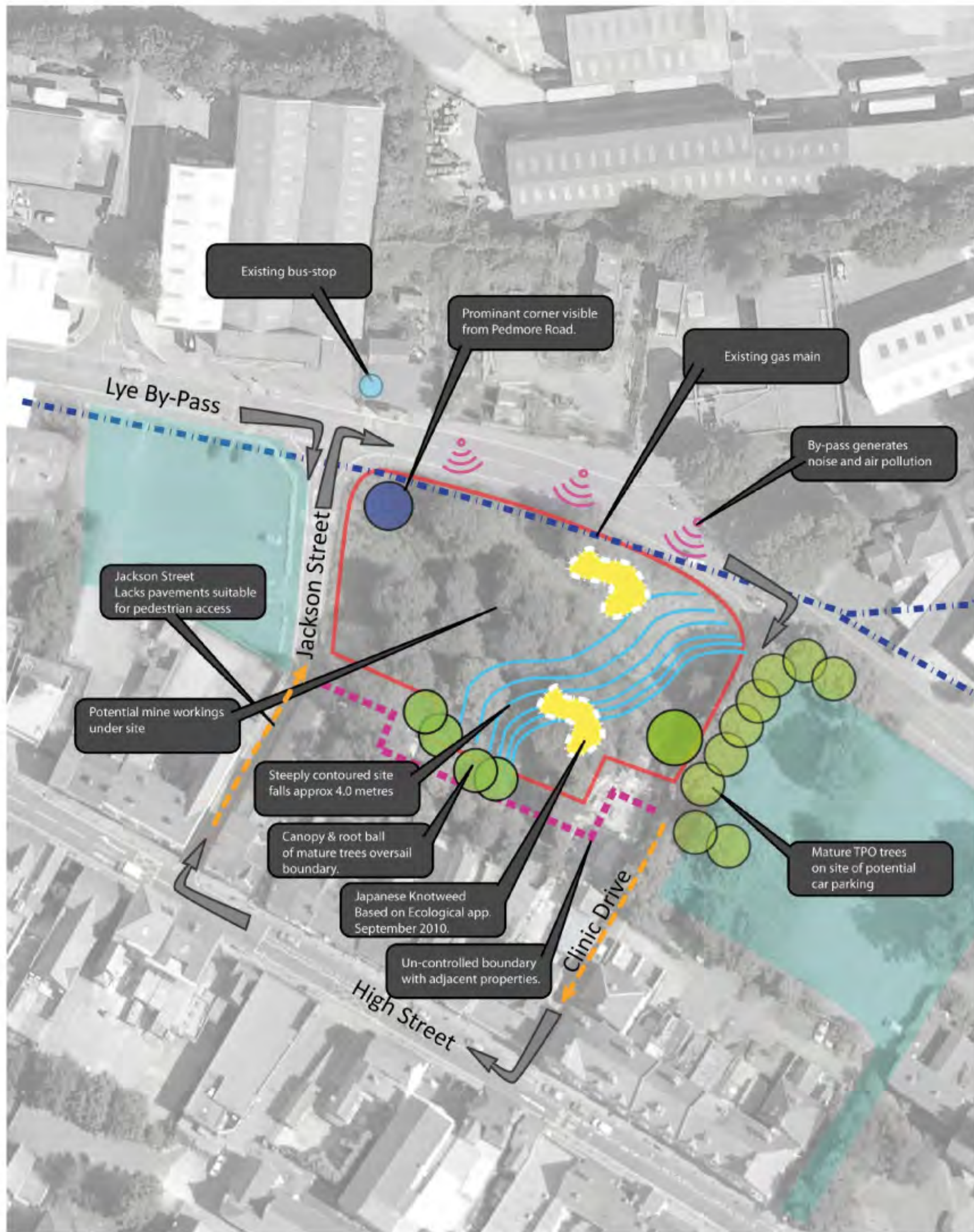

Site Constraints



**Key**

- Bus and train stops
- Direction of traffic
- Trees
- Protected shop front
- Building frontline
- View
- Pedestrian access
- Dust and pollution
- Noise
- Available car park

Site Analysis in wider context

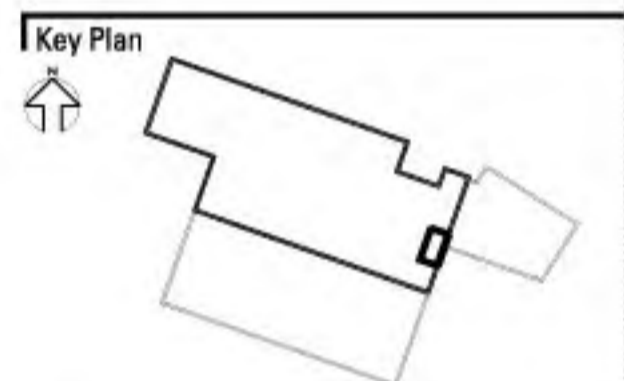

DO NOT SCALE FROM DRAWING ALL DIMENSIONS TO BE CHECKED ON SITE

FOR PLANNING APPROVAL

**ARCHITECTS** **sha** STEFFIAN ARCHITECTS  
 200 St John Street  
 London  
 EC1V 4RN  
 T (020) 7549 4050  
 F (020) 7549 4051  
 www.steffian.com

Project Number 8202.000 Scale A1

Client Dudley Infracare LIFT Ashley House PLC

Project Lye Health Centre

Title Existing Site Analysis & Site Constraints

Drawing No A-DWG-050-01-P Revisions R03



Clinic Drive view

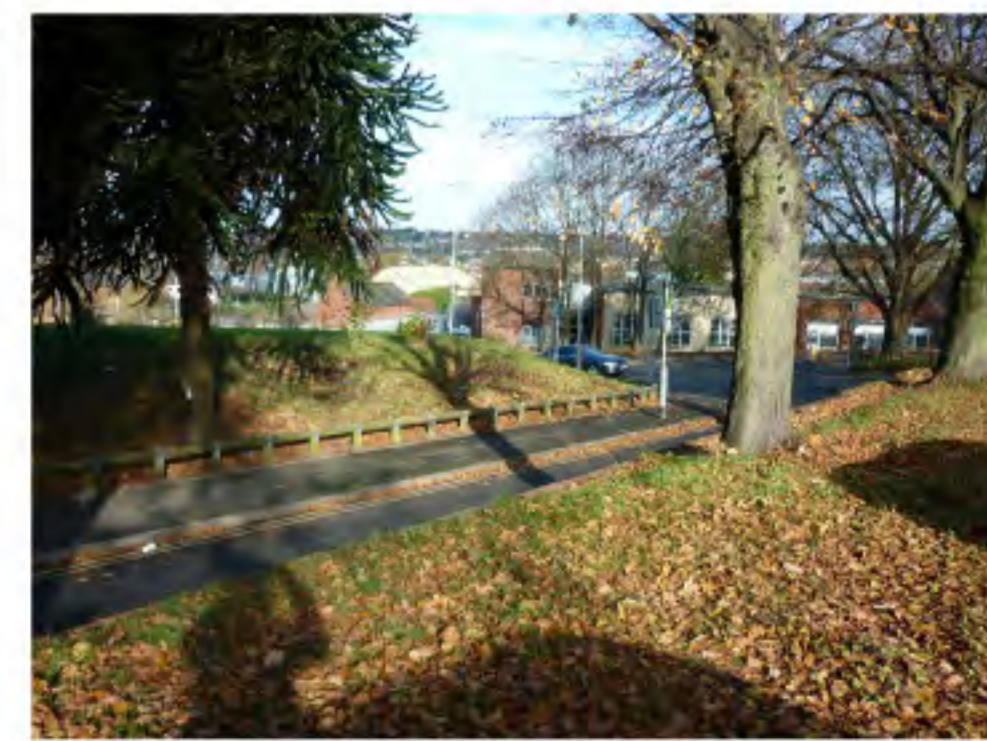

View from Jackson Street towards site Single side pedestrian access. 'One-way' road towards Lye High Street.



View towards site

Date	Drawn	Checked	Approved

Rev.	Date	Description	By
R01	30.03.12	Planning Issue	SG
R02	22.10.12	Planning Issue	ST

Notes

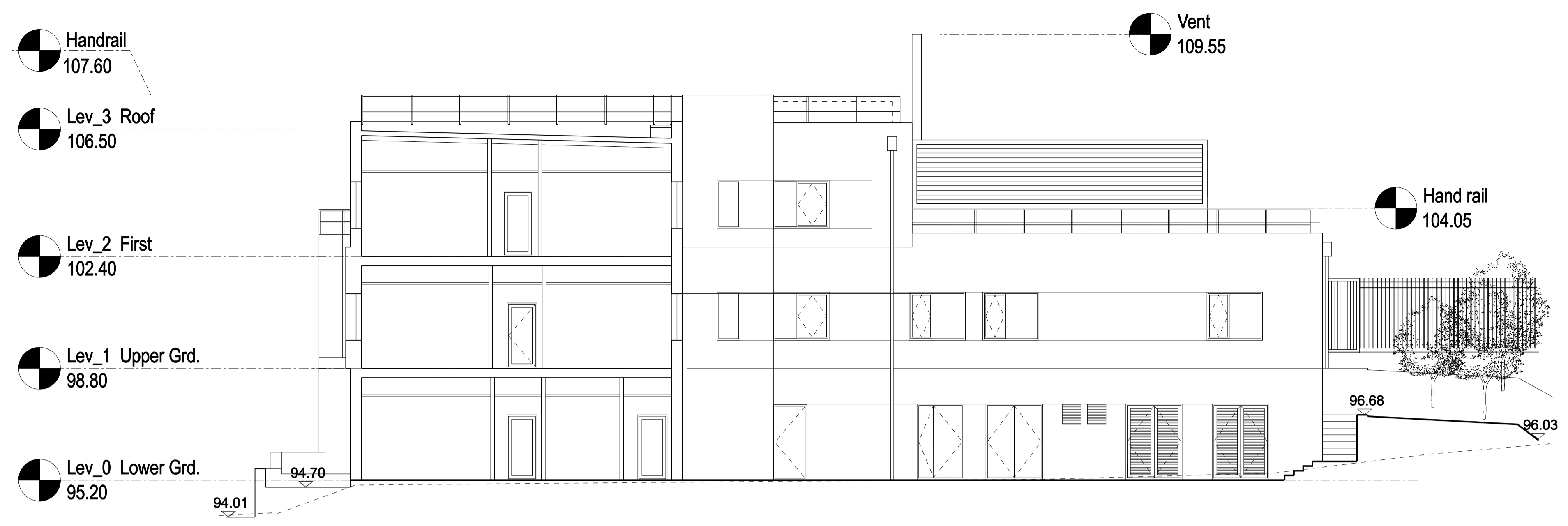

Section A

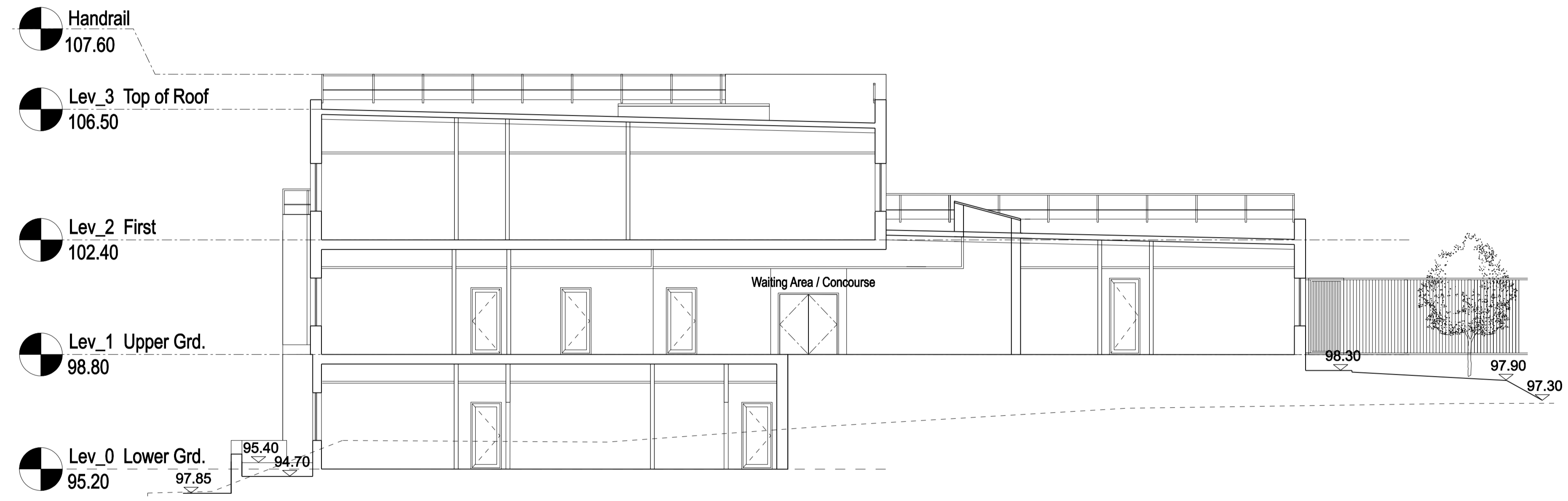

Section B

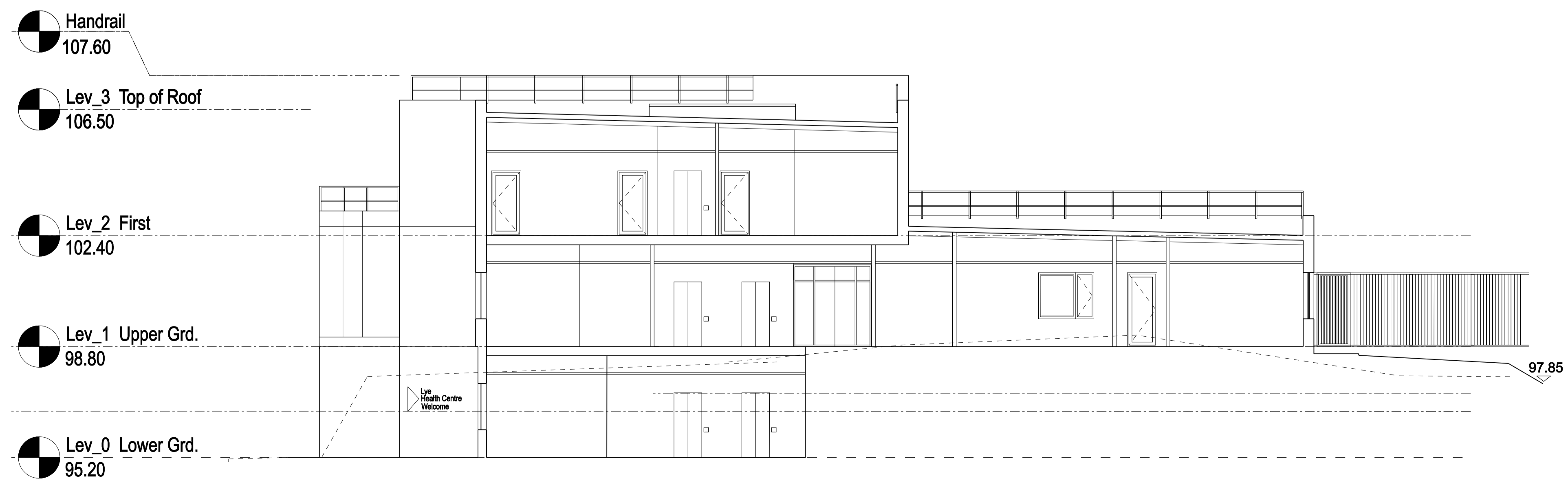

Section C

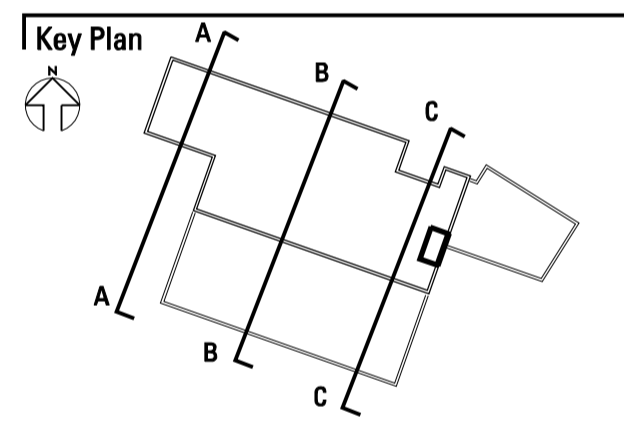

DO NOT SCALE FROM DRAWING ALL DIMENSIONS TO BE CHECKED ON SITE

FOR PLANNING APPROVAL

**ARCHITECTS** **sh**  
 200 St John Street  
 London  
 EC1V 4RN  
 T (020) 7549 4050  
 F (020) 7549 4051  
 www.steffian.com

Project Number	Scale	A1
8202.000	1:100	

Client  
**Dudley Infracare LIFT  
 Ashley House PLC**

Project  
**Lye Health Centre**

Title  
**Building Sections**

Drawing No	Revisions
<b>A-DWG-301-00-P</b>	<b>R02</b>

Date	Drawn	Checked	Approved
03/03/12	SG	DH	RC
Plotted: datedatedatedated			
By: usernameuser			



Rev.	Date	Description	By
R01	30.03.12	Planning Issue	SG
R02	30.03.12	Planning Issue	SG
R03	02.04.12	Planning Issue	SG
R04	29.10.12	Planning Issue	ST

Notes



Ariel view from By-pass Road towards staff entrance corner



Ariel view from By-pass Road towards pharmacy building



View from Jackson Street towards Staff Entrance



Rear View towards Patient drop off and visitors car park

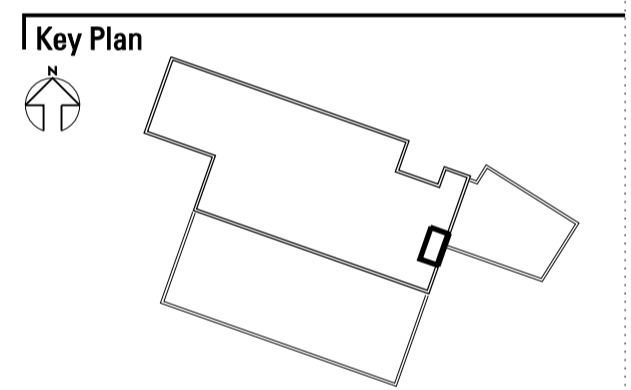

DO NOT SCALE FROM DRAWING ALL DIMENSIONS TO BE CHECKED ON SITE

FOR PLANNING APPROVAL

**ARCHITECTS** **sha** STEFFIAN ARCHITECTS  
 200 St John Street  
 London  
 EC1V 4RN  
 T (020) 7549 4050  
 F (020) 7549 4051  
 www.steffian.com

Project Number 8202.000 Scale NOT TO SCALE A1

Client Dudley Infracare LIFT Ashley House PLC

Project Lye Health Centre

Title

Illustrations/ Perspective

Drawing No A-DWG-060-01-P Revisions R04

Date	Drawn	Checked	Approved
03/03/12	SG	DH	RC
File: d:\p\060\060-01-p.dwg Plotted: d:\p\060\060-01-p.dwg By: userameuser			

Rev.	Date	Description	By
R01	30.03.12	Planning Issue	SG
R02	30.03.12	Planning Issue	SG
R03	06.11.12	Planning Issue	SG

Notes

- Walkway
- Mansafe system
- Overflow
- Hopper & downpipe

Key Plan

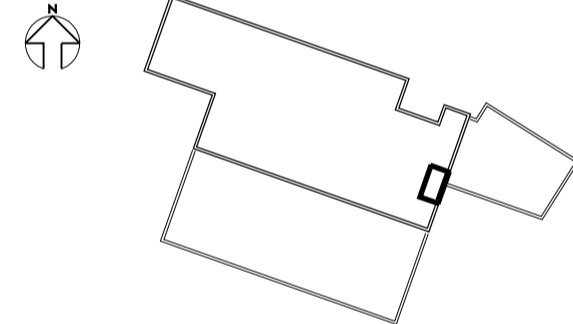

**DO NOT SCALE FROM DRAWING ALL DIMENSIONS TO BE CHECKED ON SITE**

FOR PLANNING APPROVAL

**ARCHITECTS** **sha** STEFFIAN  
200 St John Street  
London  
EC1V 4RN  
T (020) 7549 4050  
F (020) 7549 4051  
www.steffian.com

Project Number **8202.000** Scale **1:200 @ A1**

Client **Dudley Infracare LIFT  
Ashley House PLC**

Project **Lye Health Centre**

Title **General Arrangement Plan  
Roof Plan**

Drawing No **A-DWG-101-04-P** Revisions **R03**

Date	Drawn	Checked	Approved
03/03/12	SG	DH	RC

Plotter: data dated  
By: usernamouser

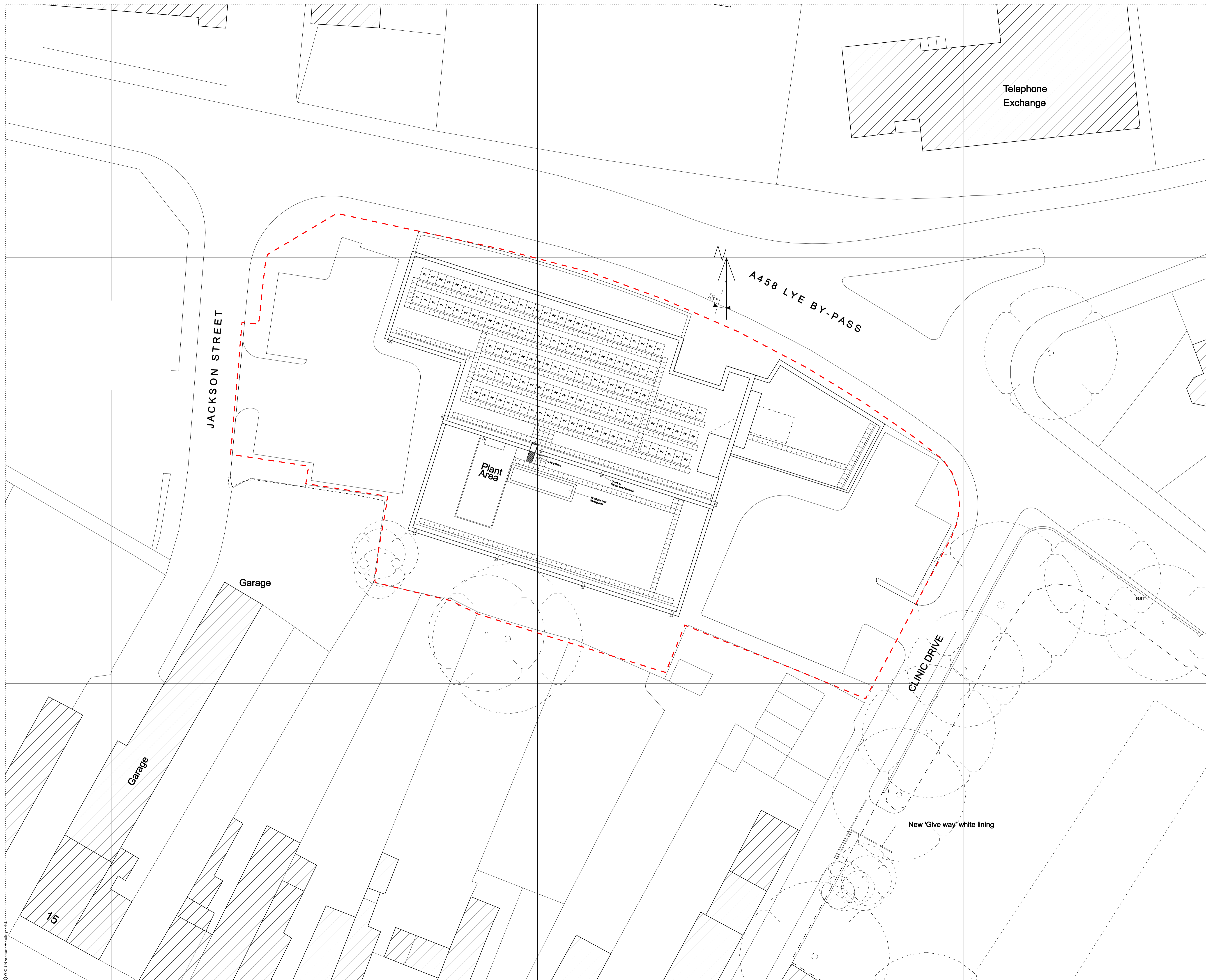

Rev.	Date	Description	By
R01	30.03.12	Planning Issue	SG
R02	30.03.12	Planning Issue	SG
R03	22.10.12	Planning Issue	ST

Notes

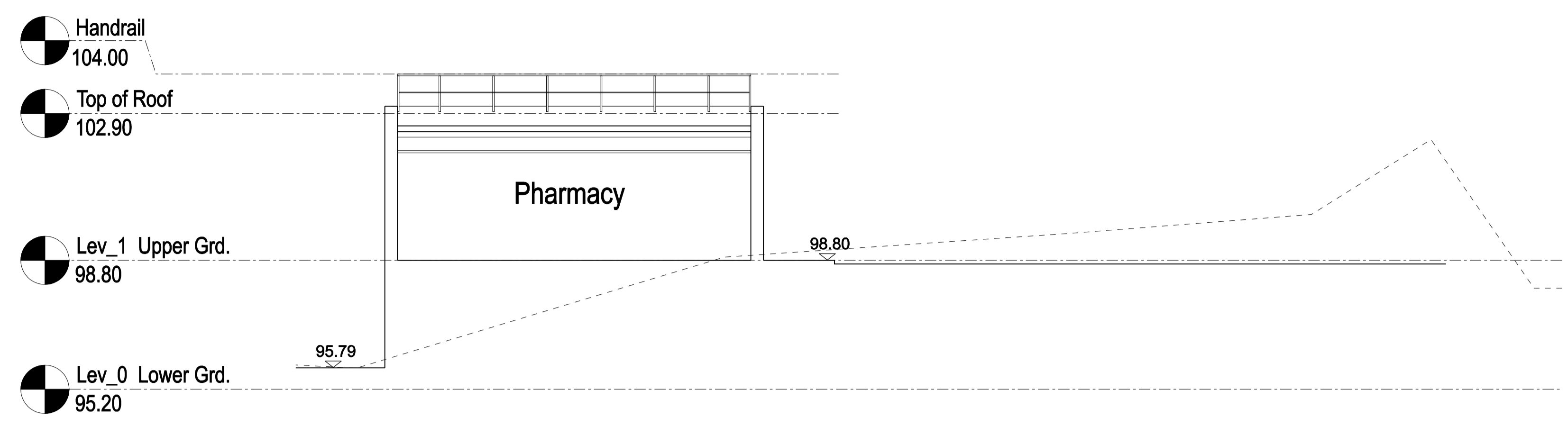

Section D

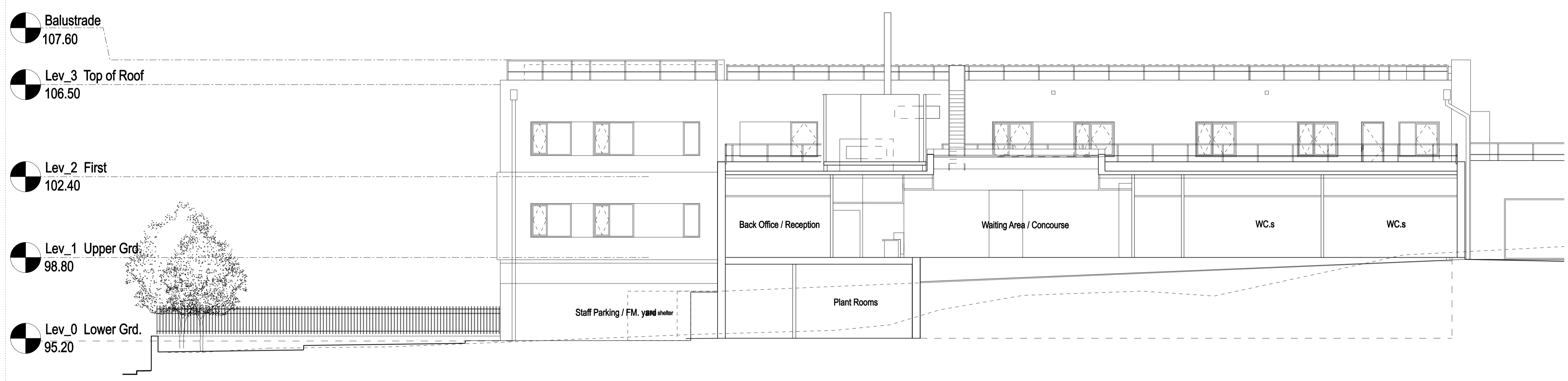

Section 1

Refer to Elevations: \_200\_2 and 200\_3

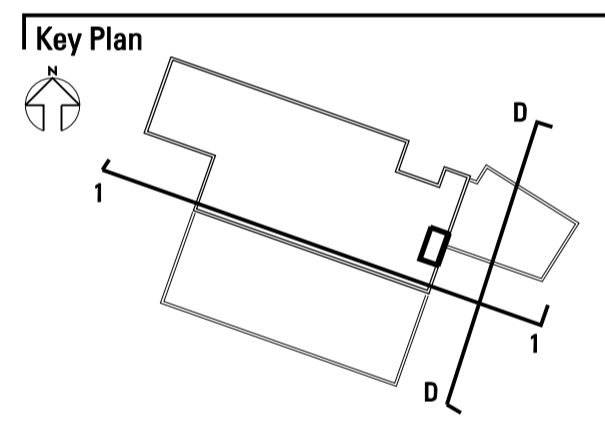

DO NOT SCALE FROM DRAWING ALL DIMENSIONS TO BE CHECKED ON SITE

FOR PLANNING APPROVAL

**ARCHITECTS** **sha** STEFFIAN  
 200 St John Street  
 London  
 EC1V 4RN  
 T (020) 7549 4050  
 F (020) 7549 4051  
 www.steffian.com

Project Number	Scale
8202.000	1:100 A1

Client  
**Dudley Infracare LIFT  
 Ashley House PLC**

Project  
**Lye Health Centre**

Title  
**Building Sections**

Drawing No	Revisions
<b>A-DWG-302-00-P</b>	<b>R03</b>

Date	Drawn	Checked	Approved
03/03/12	SG	DH	RC

Plotted: datedatedatedated  
 By: usernameuser

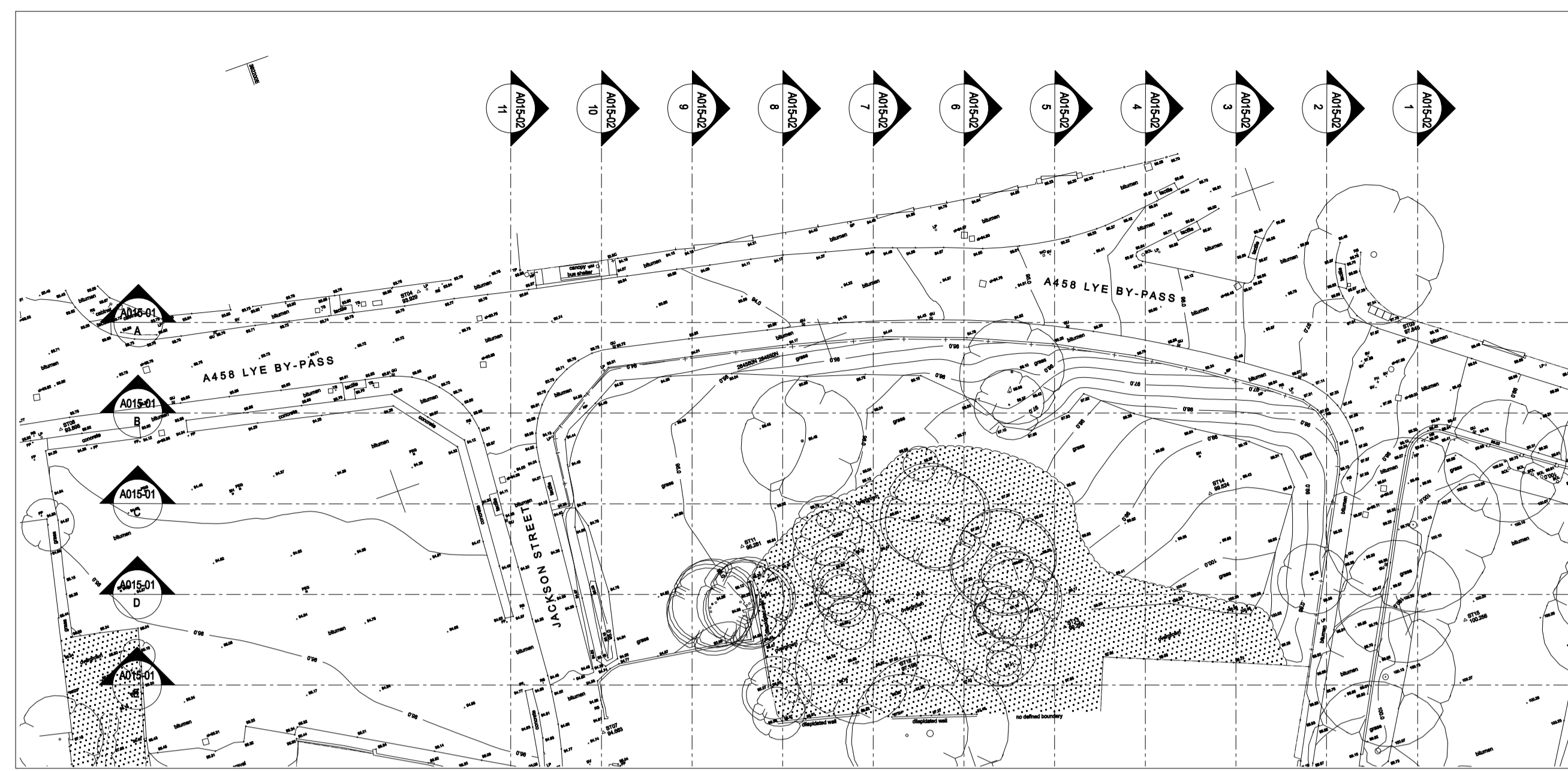

Rev.	Date	Description	By
R01	30.03.12	Planning Issue	SG
R02	30.03.12	Planning Issue	SG

**Notes**

Total Site Area 2,989m<sup>2</sup> (0.298 ha)

Read in conjunction with drawing:  
A-DWG-015-02

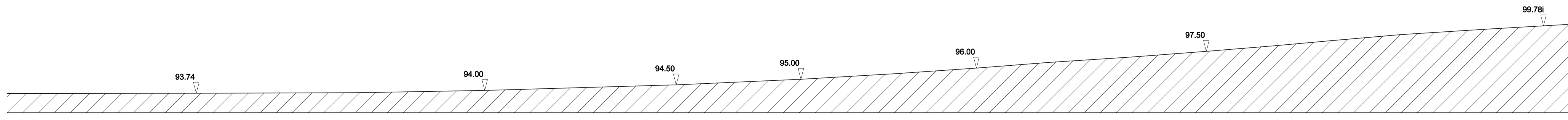

Section A

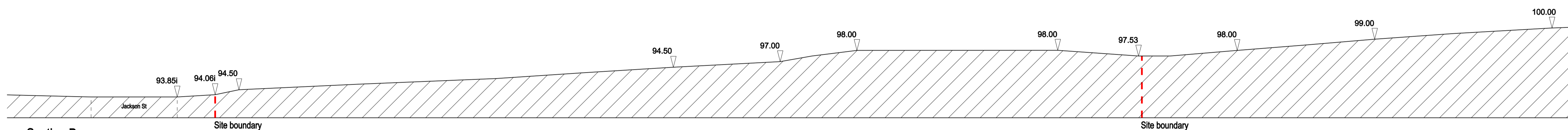

Section B

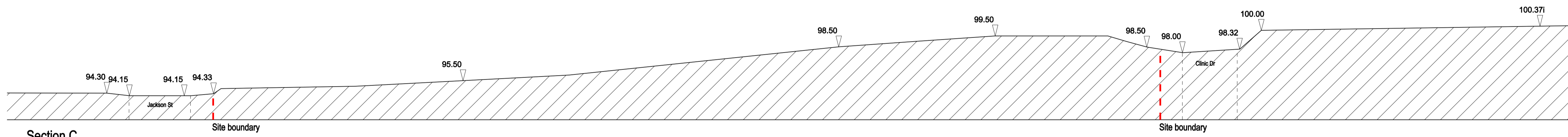

Section C

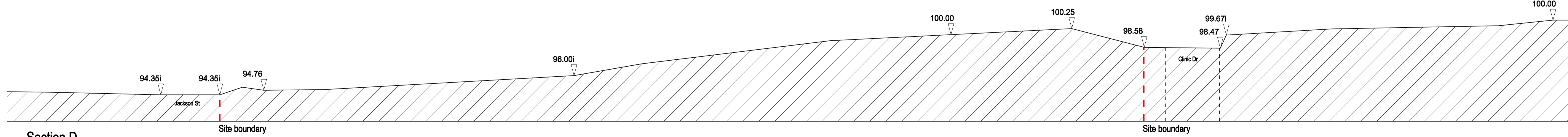

Section D

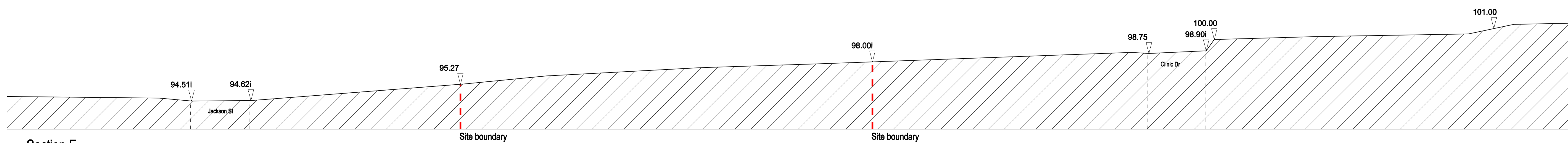

Section E

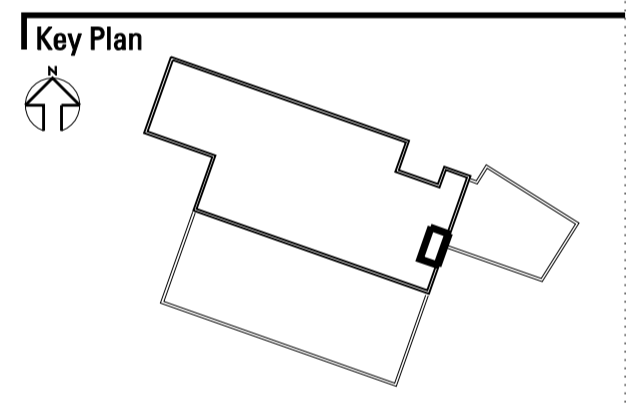

**DO NOT SCALE FROM DRAWING ALL DIMENSIONS TO BE CHECKED ON SITE**

**FOR PLANNING APPROVAL**

**ARCHITECTS**  
shb  
200 St John Street  
London  
EC1V 4RN  
T (020) 7549 4050  
F (020) 7549 4051  
www.steffian.com

Project Number	Scale	A1
8202.000	1:200	

**Client**  
Dudley Infracare LIFT  
Ashley House PLC

**Project**  
Lye Health Centre

**Title**  
Existing Site Sections  
East/West

Drawing No	Revisions
A-DWG-015-01-P	R02

Date	Drawn	Checked	Approved
03/03/12	KJ	SG	RC
Plotted: datedatedatedated By: usernameuser			